

STAP 1 : Bevestiging van de profielen en hoekprofielen

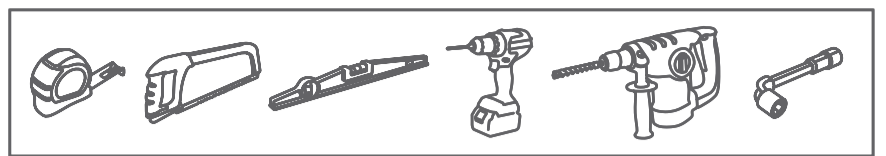

Ijzerwaren

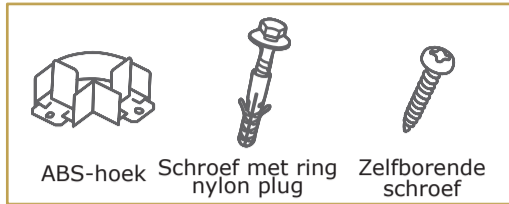
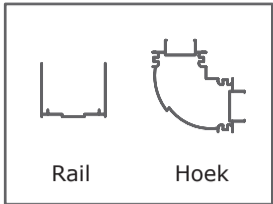

Bevestiging aan het bestaande plafond

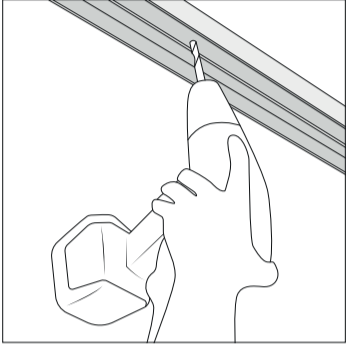

Bevestiging van de kantoorwand op de grond

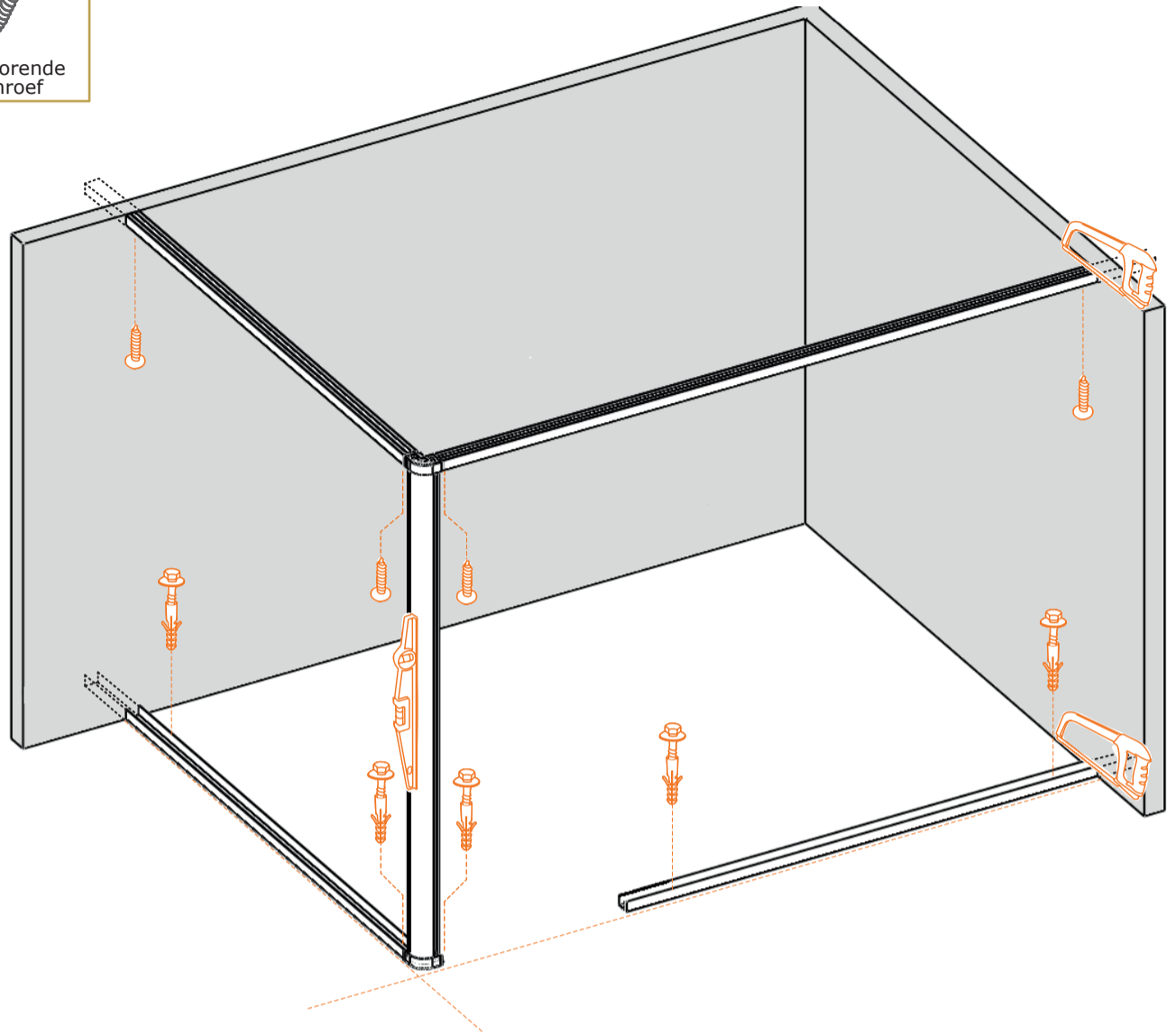
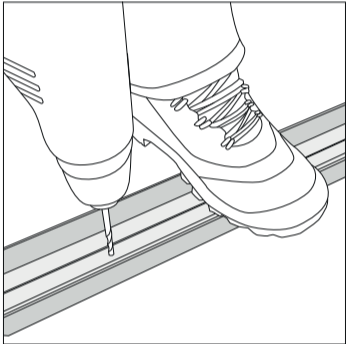

STAP 2 : Plaatsing en bevestiging van de standers



Ijzerwaren

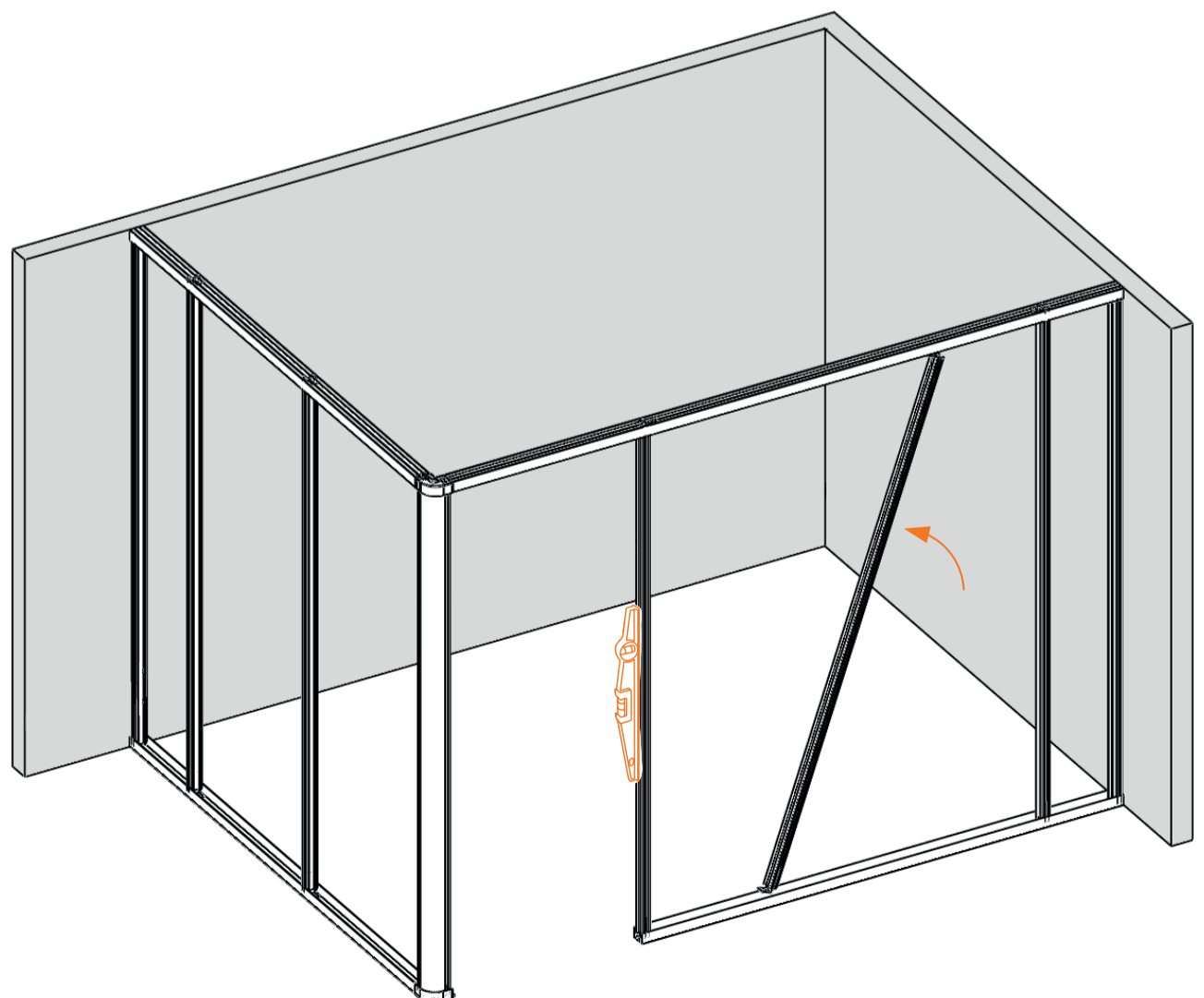
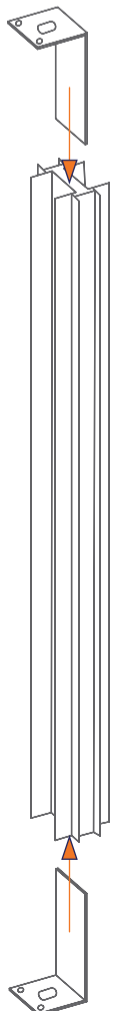
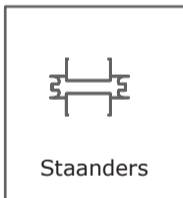

- plaats aan elk uiteinde van de stander een hoeksteun
- plaats de standers in de rails en controleer of ze loodrecht staan
- bevestig de hoeksteunen in de onderste en bovenste rails

STAP 3 : Plaatsing van dwarsbalken en melamineplaten

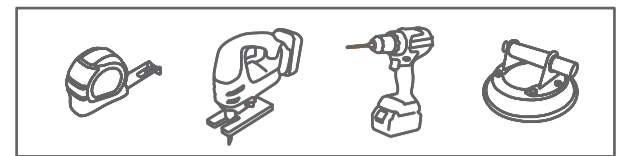

Ijzerwaren

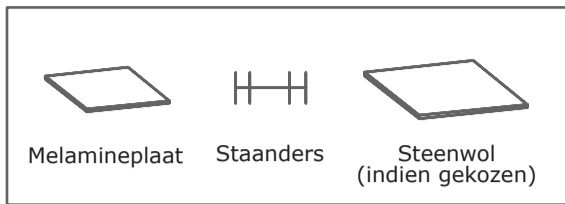

- de onderste en bovenste dwarsbalken vastschroeven
- de melamineplaten vastschroeven
- de massieve eindstukken op maat zagen
- de massieve eindstukken met de zuignap weer op hun plaats zetten, vastzetten en in de staanders vastschroeven

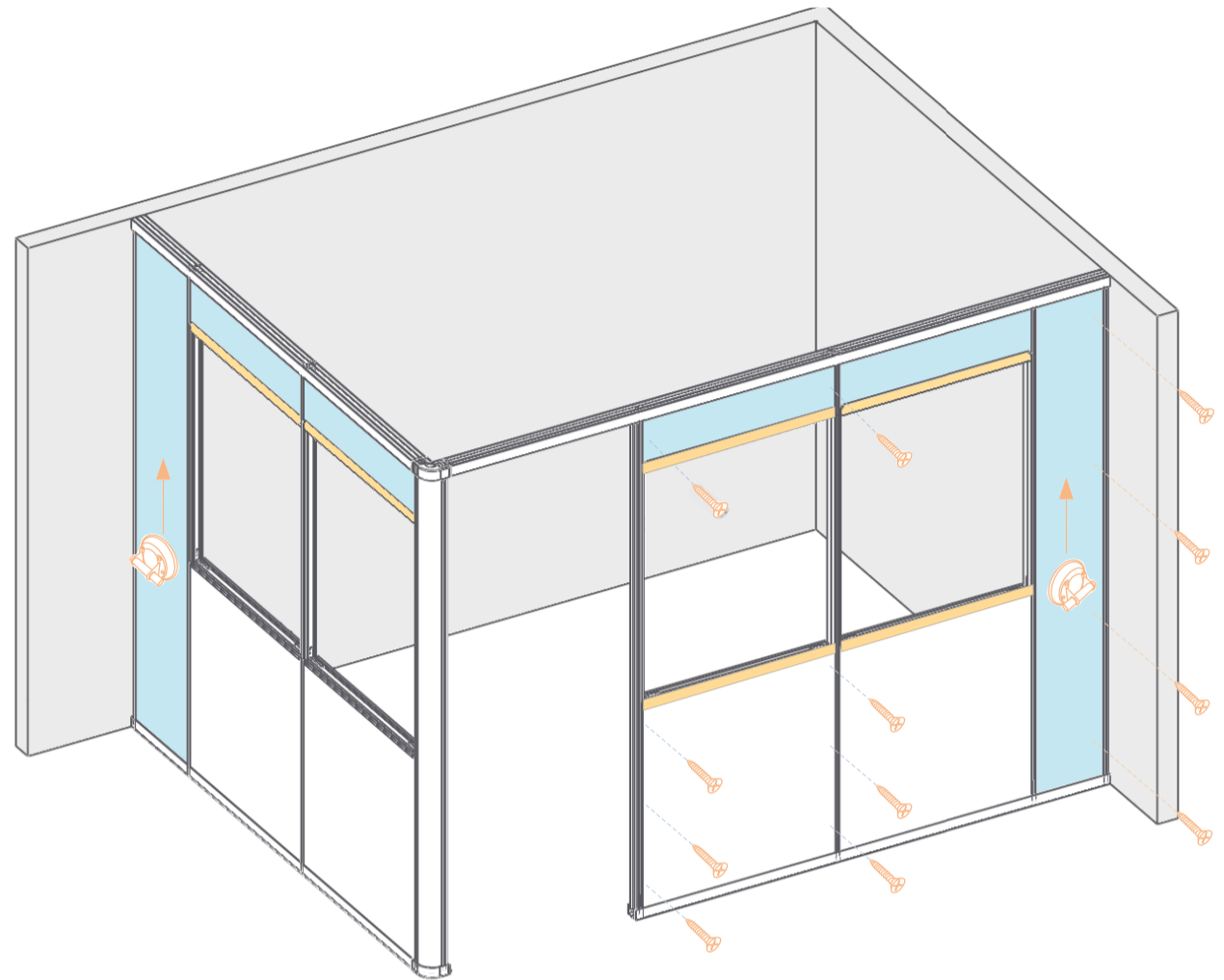
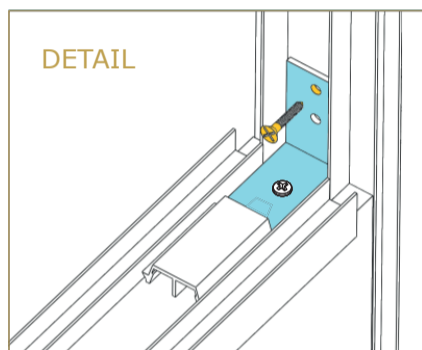

STAP 4 : Montage van afgeronde hoekafdekking, sierkap en deur

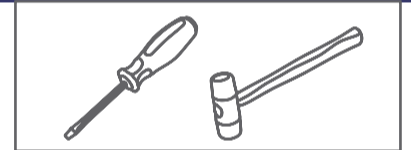

Ijzerwaren

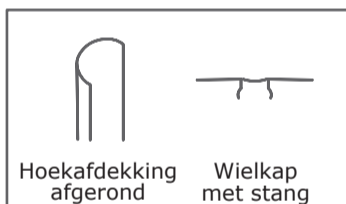

- Plaats de deur, schroef de deurlink en het cilinderslot vast
- De afdekplaat met afgeronde hoeken plaatsen
- De wielkappen vastklikken

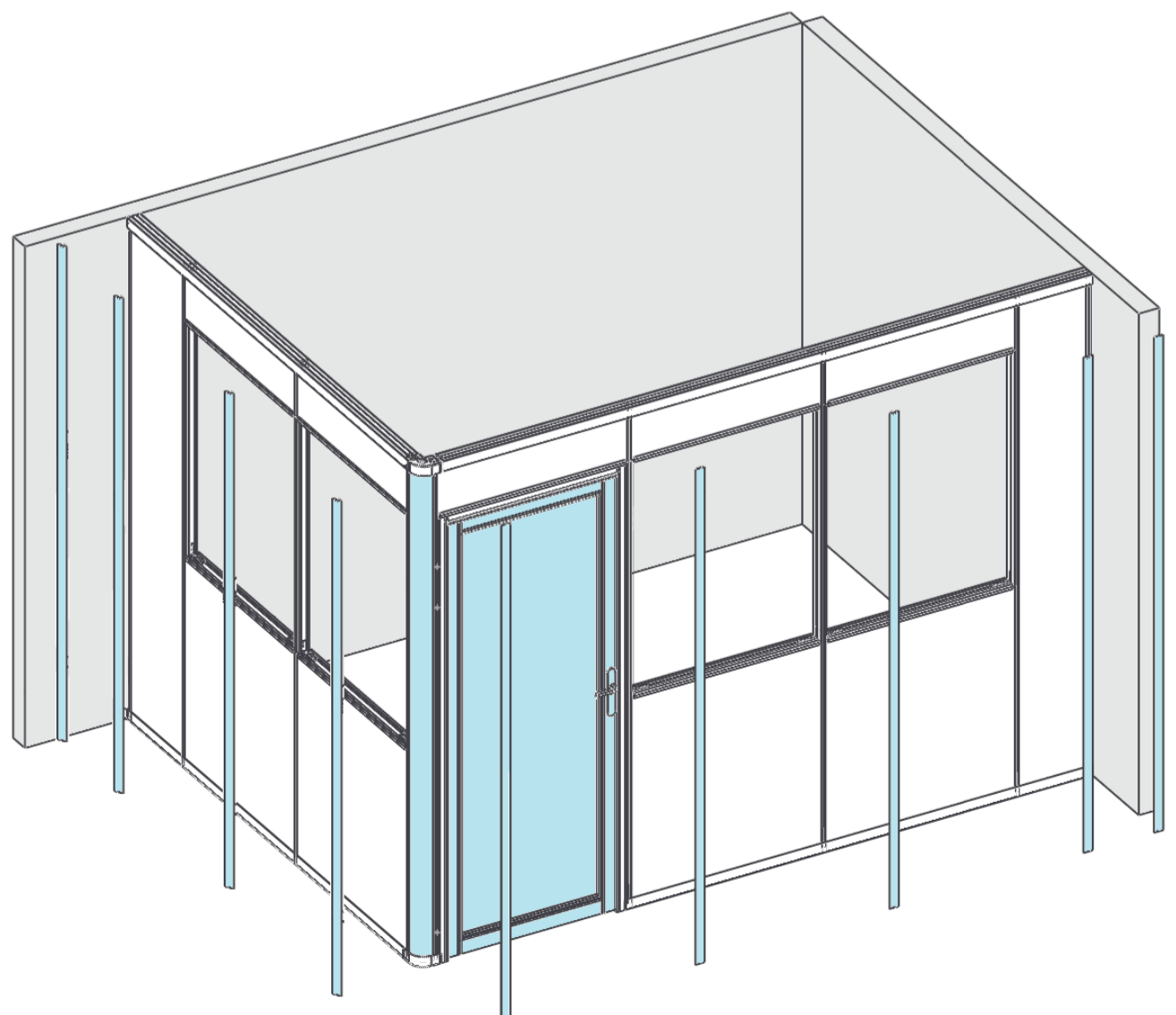

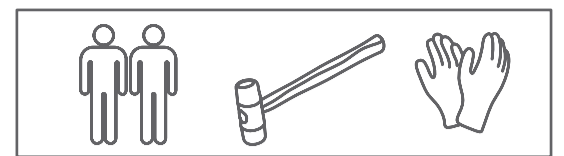

Ijzerwaren

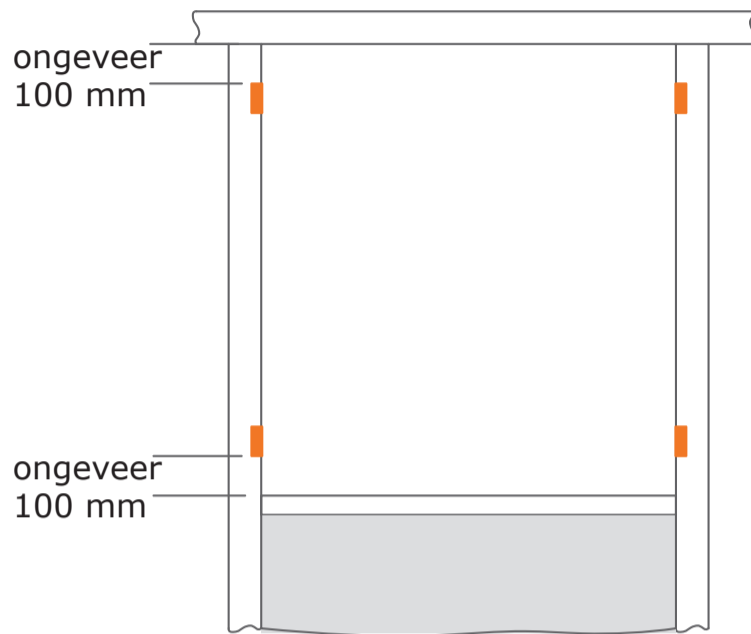
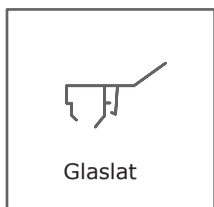

A) Bevestig per ruit 4 klemmen in de steunen op ongeveer 100 mm van de boven- en onderkant

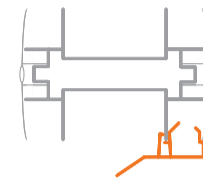

B) Bevestig 2 horizontale glaslaten (1 boven, 1 onder) aan één kant.

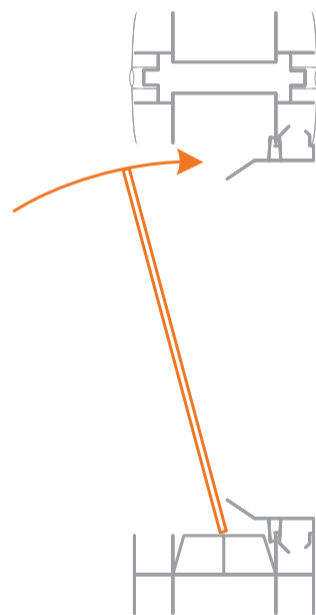

C) Plaats het glas, gebruik snijbestendige handschoenen

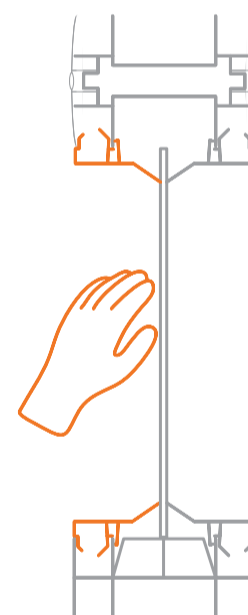

D) Het glas op zijn plaats houden

- De resterende horizontale glaslaten vastklikken
- Tot slot de verticale glaslaten bevestigen