

## VRIJSTAANDE KANTOORUNIT

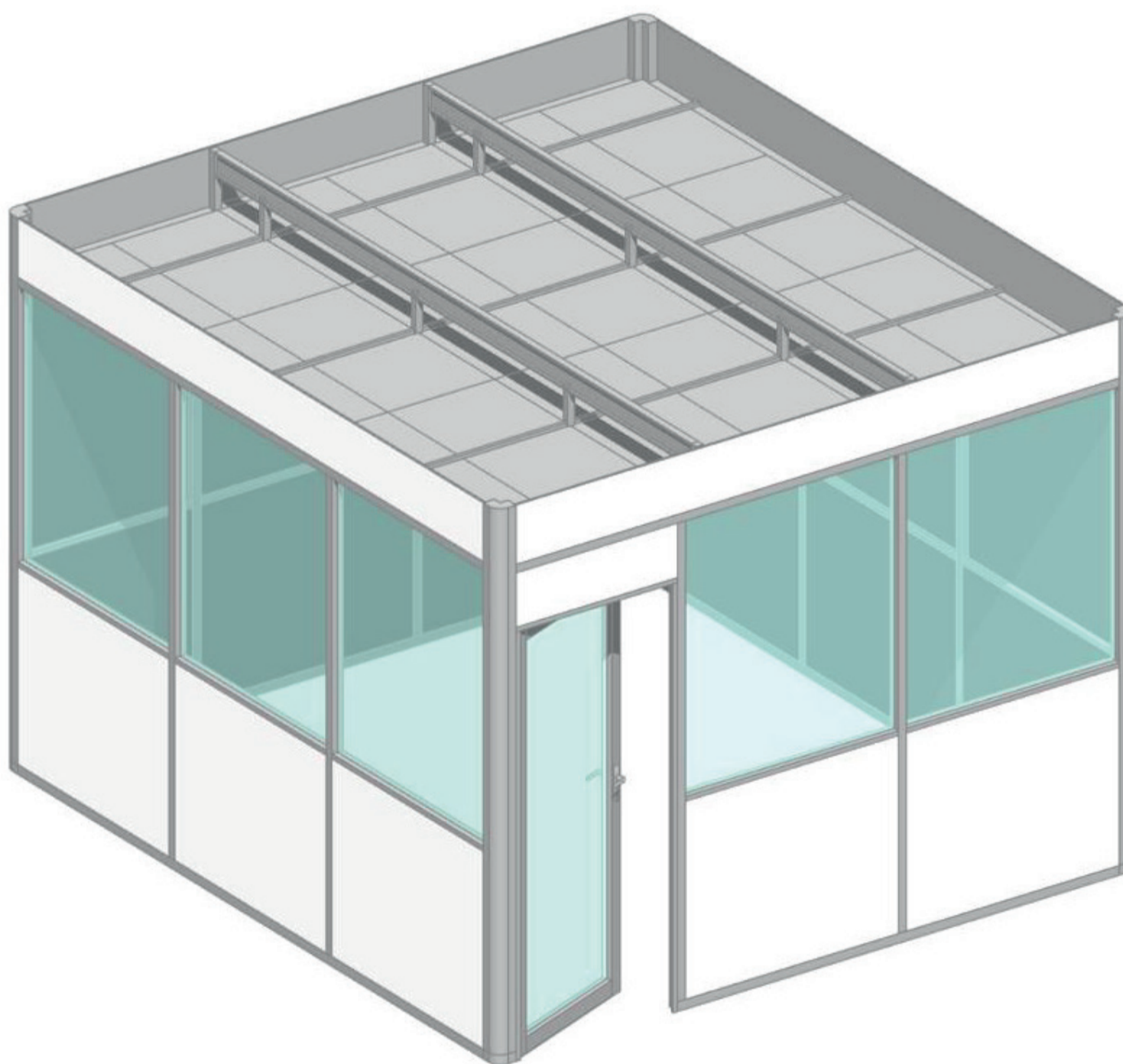

## STAP 1 : plaatsen van de rails en het bevestigen van de beugels

### Ijzerwaren

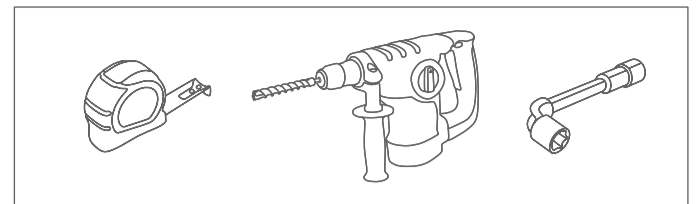
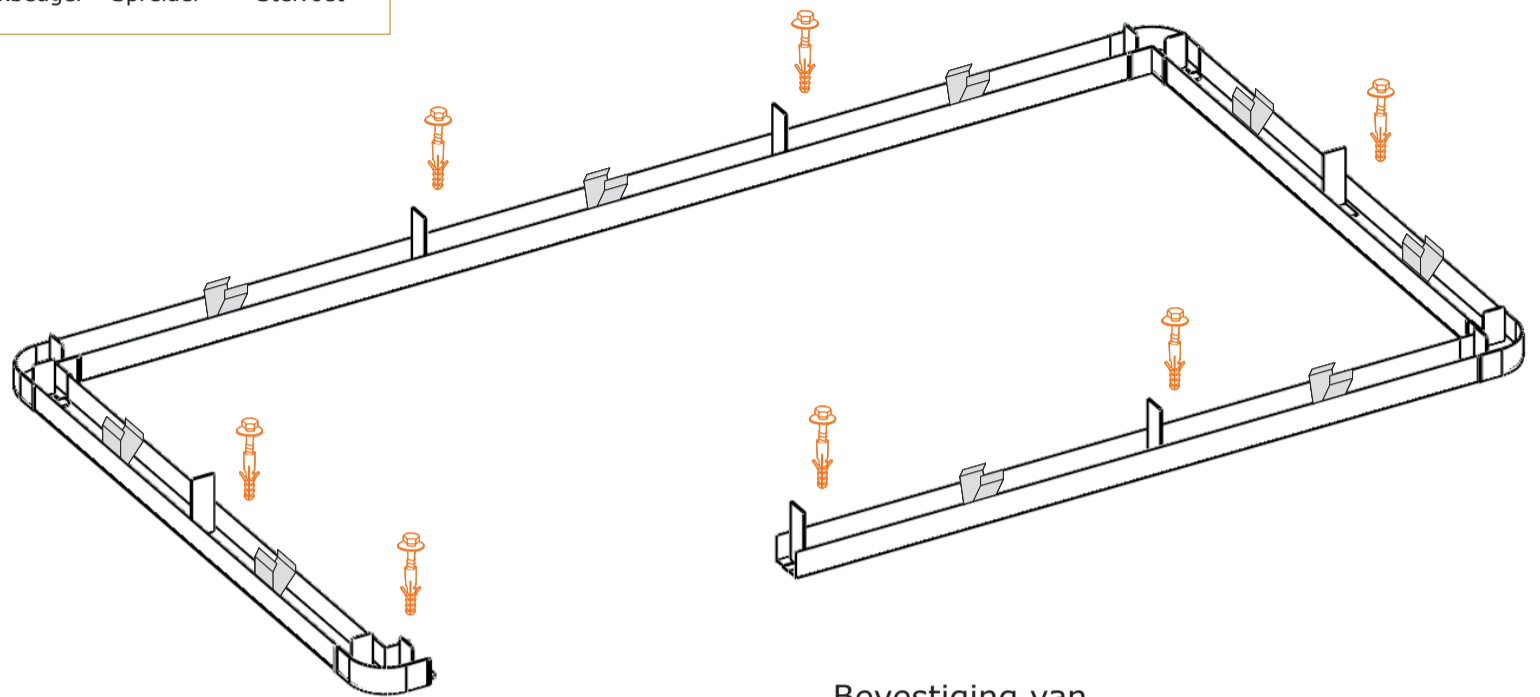
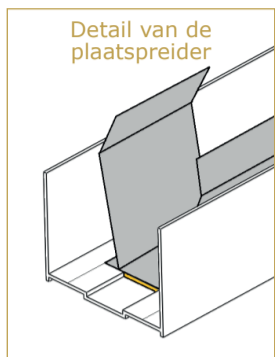
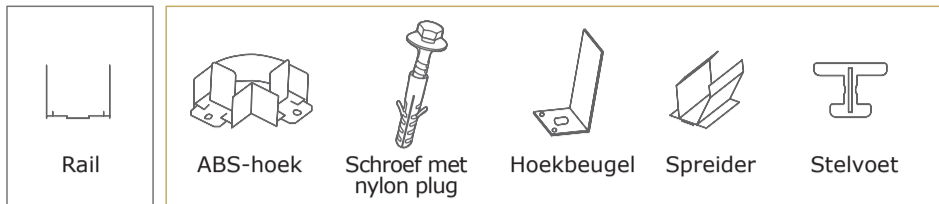

Bevestiging van de kantoorwand op de grond

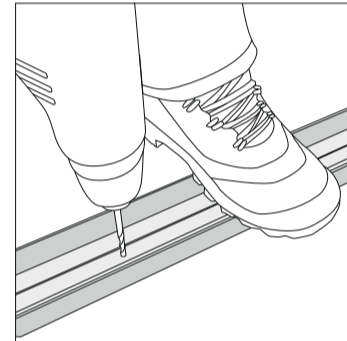

Regelbare vloer tot 40 mm

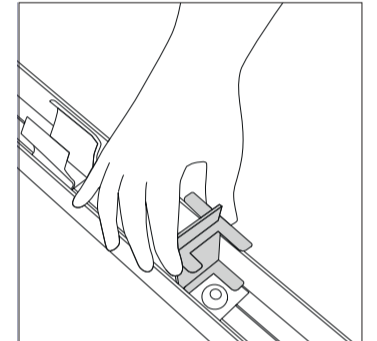

## STAP 2 : montage van het frame en bevestiging van de melamineplaten

### Ijzerwaren

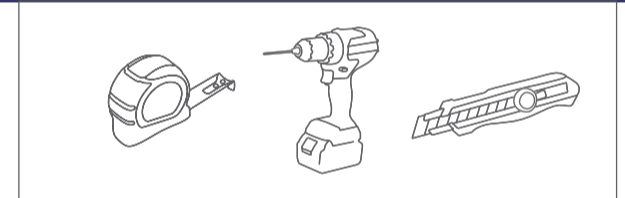
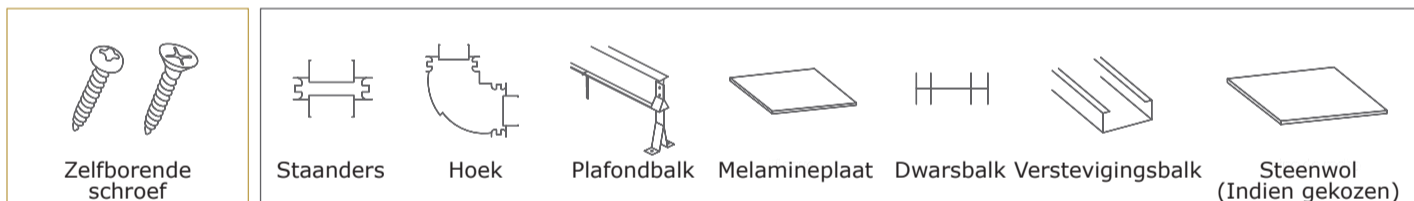

- Schuif de staanders en de hoeken op de hoekijzers
- Plaats de bovenregels en schroef ze vast aan de hoeken
- Verdeel de balken ongeveer op gelijke afstand en schroef ze vast in de bovenregels
- Schroef de U-vormige verstevigingsbalken op de balken en de hoeken
- controleer in deze fase of alles waterpas is
- Schroef de melamineplaten vast
- Plaats de dwarsbalken
- Schroef alle dwarsbalken vast

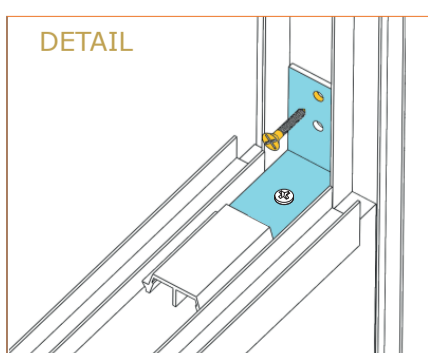

## STAP 3 : Plaatsing van het plafond en de afwerklijst

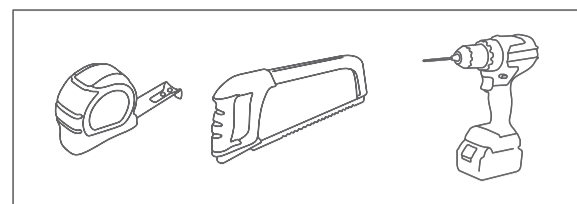

### Ijzerwaren

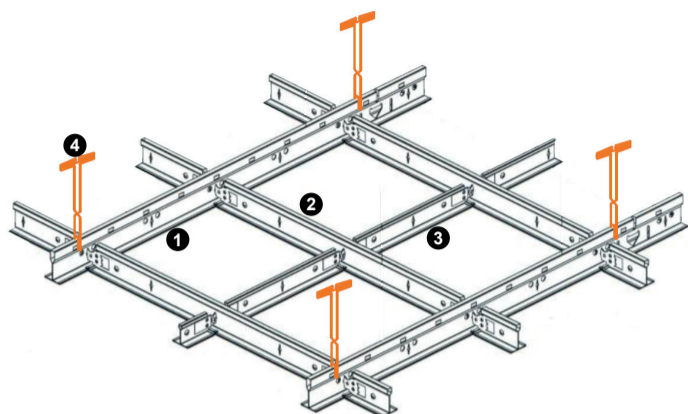
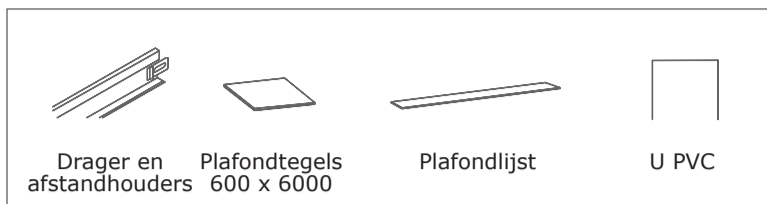

- 1 Drager 3600
- 2 Afstandhouder 1200
- 3 Afstandhouder 600
- 4 Ophangbeugel

Glaswol (indien gekozen)

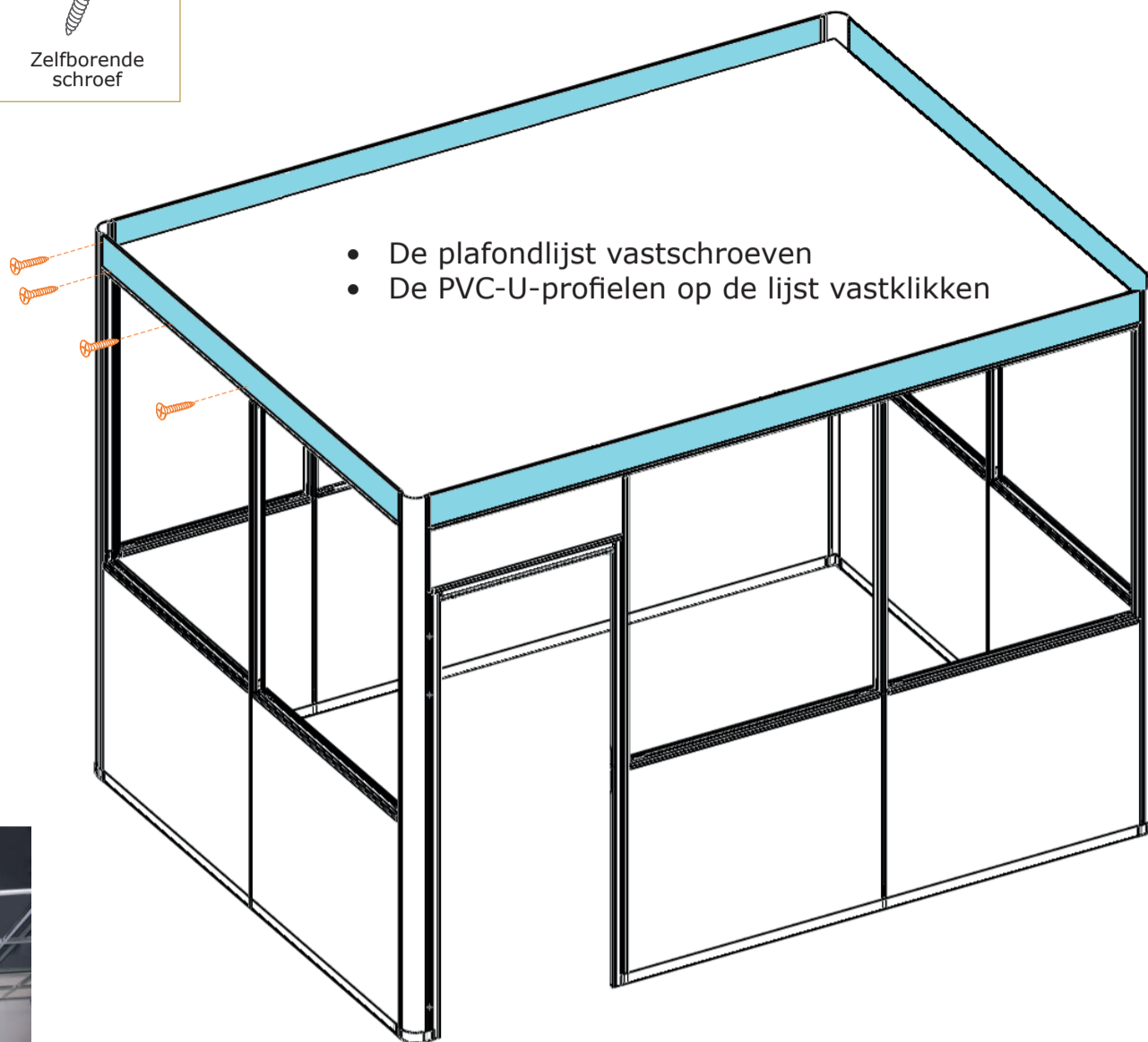
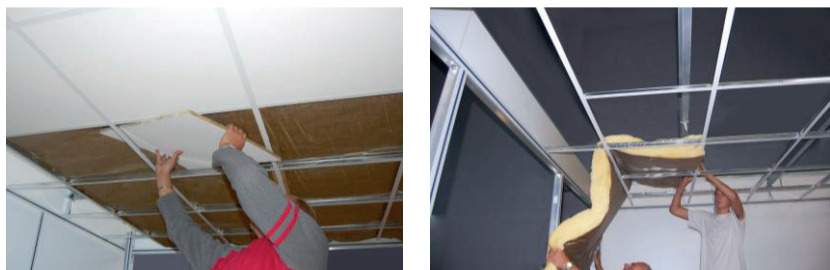

## STAP 4 : Plaatsing van deur, afgeronde hoekafdekking en de omlijsting

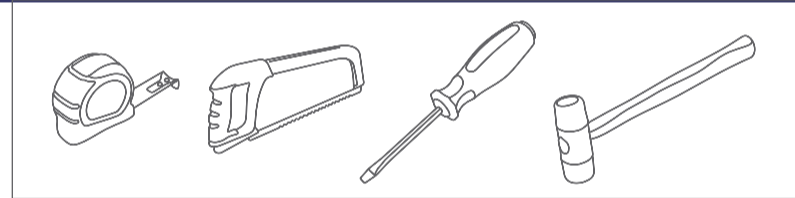

### Carton quincaillerie

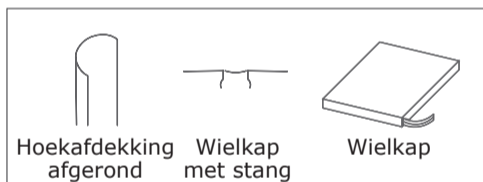

- Plaats de deur, schroef de deurlink en het cilinderslot vast
- Plaats de afgeronde hoekafdekking
- Klik de strips op de stang vast, evenals op de hoek
- Pas de bolvormige strips aan en klik deze vast op de bovenste regel
- Klik de strips vast op de standers

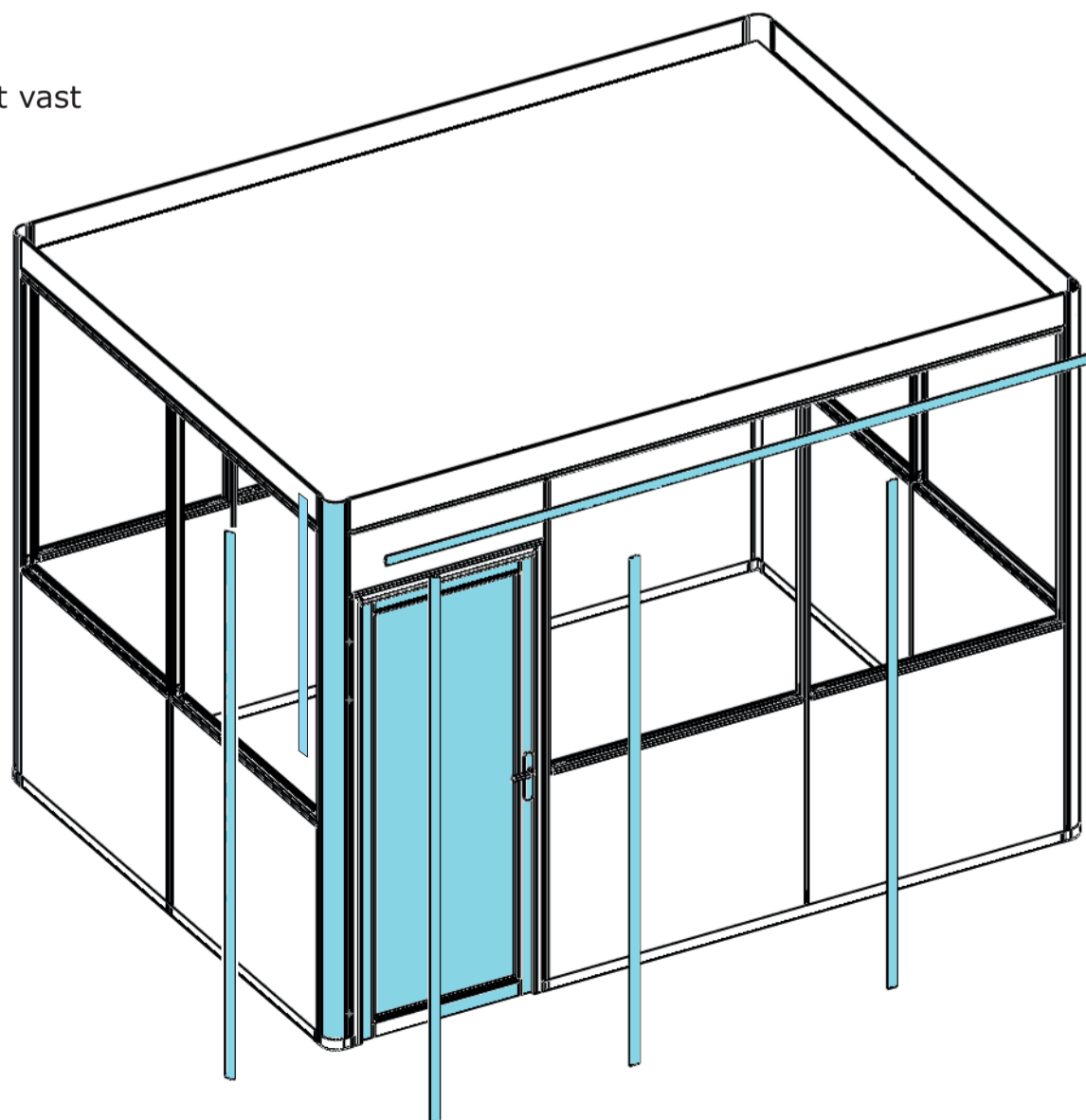

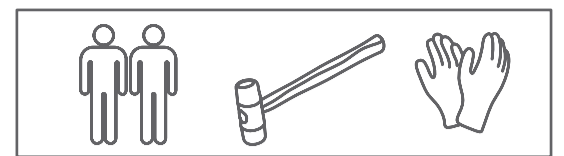

Ijzerwaren

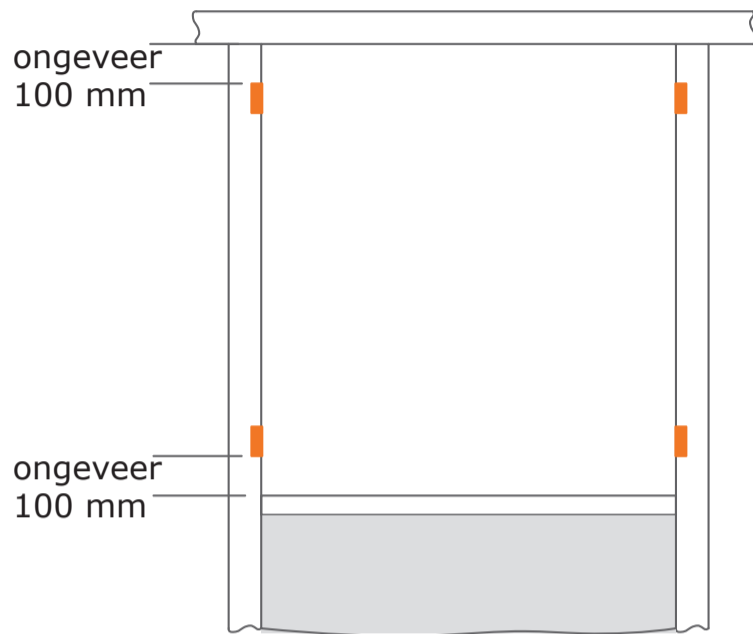
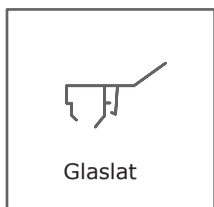

**A)** Bevestig per ruit 4 klemmen in de steunen op ongeveer 100 mm van de boven- en onderkant

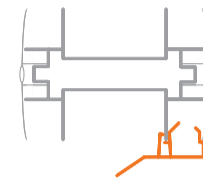

**B)** Bevestig 2 horizontale glaslaten (1 boven, 1 onder) aan één kant.

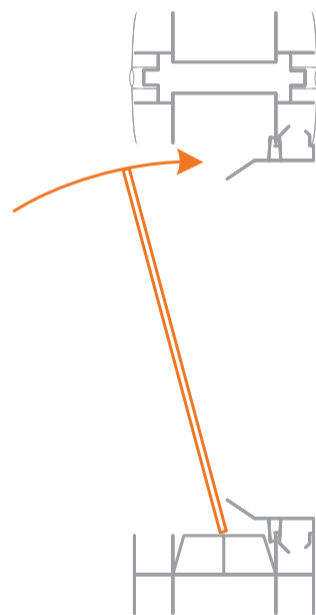

**C)** Plaats het glas, gebruik snijbestendige handschoenen

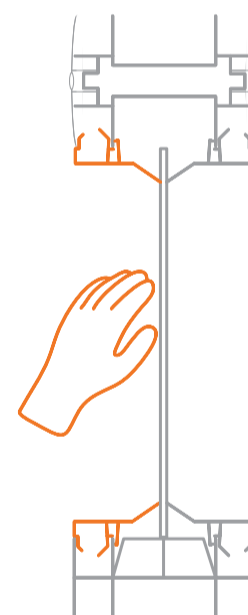

**D)** Het glas op zijn plaats houden

- De resterende horizontale glaslaten vastklikken
- Tot slot de verticale glaslaten bevestigen

## KANTOORUNIT TEGEN MUUR

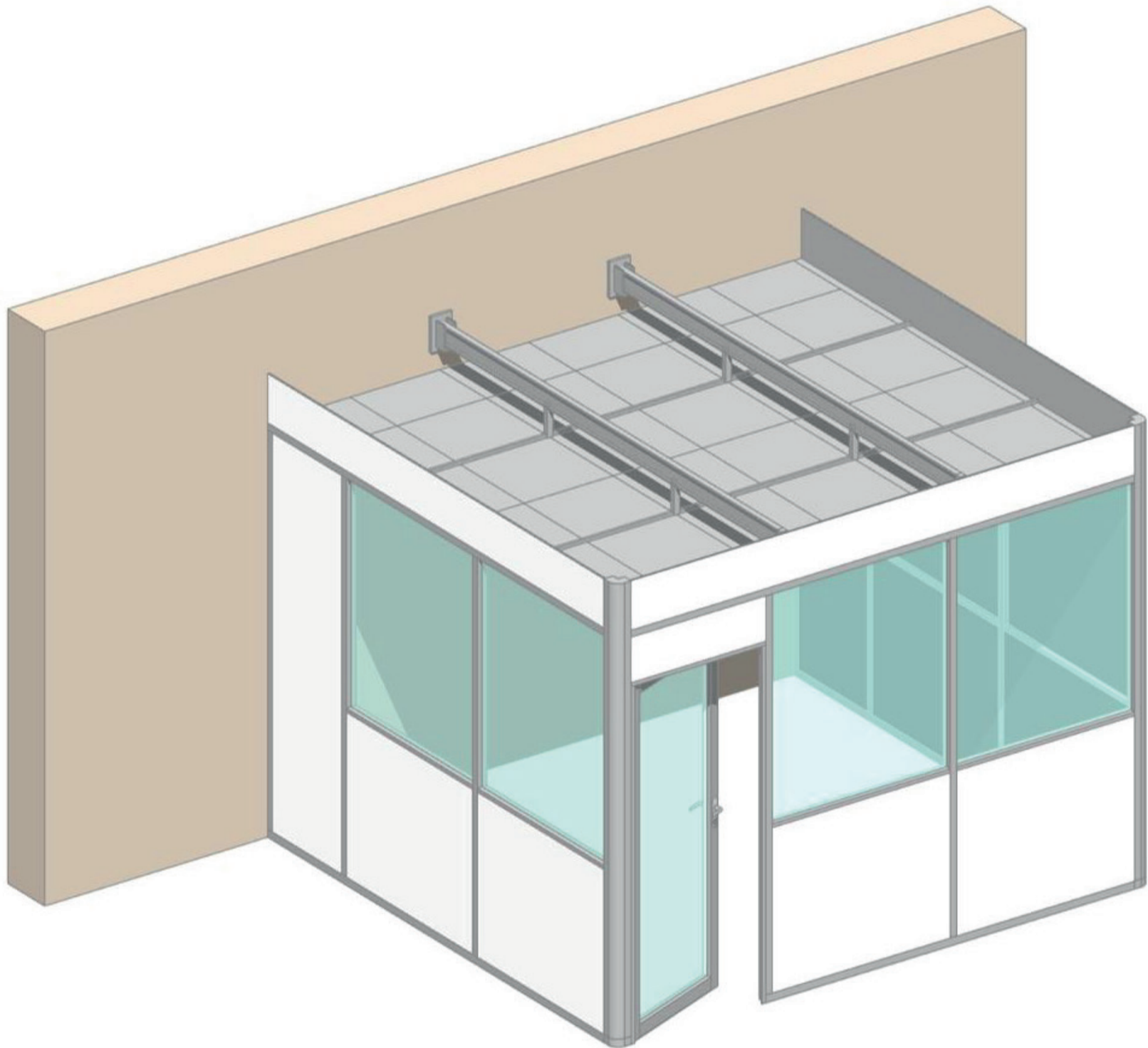

## STAP 1 : plaatsen van de rails en het bevestigen van de beugels

### Ijzerwaren

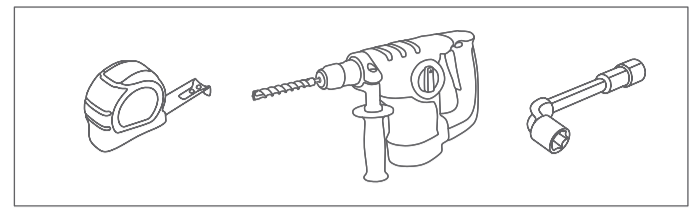
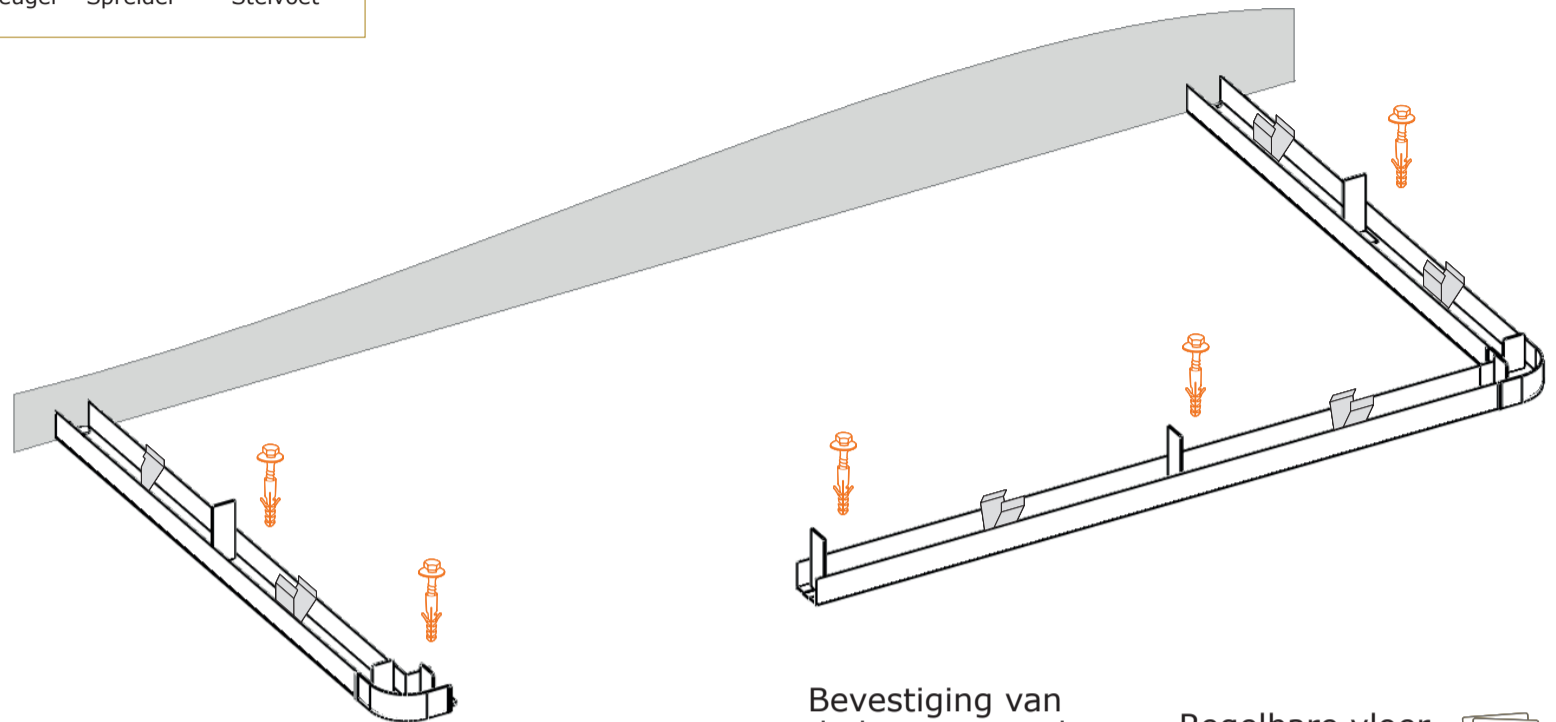
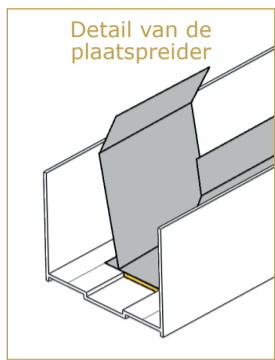
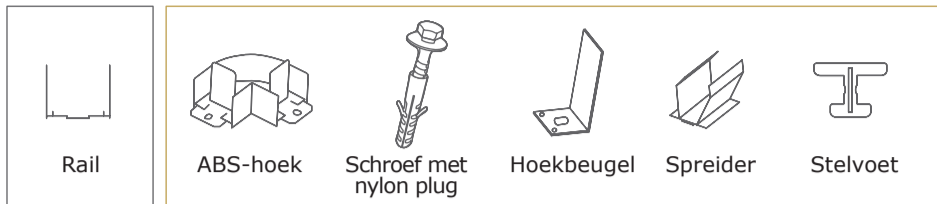

Bevestiging van de kantoorwand op de grond

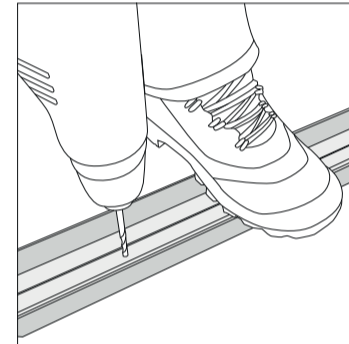

Regelbare vloer tot 40 mm

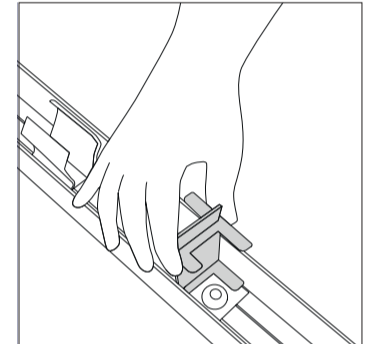

## STAP 2 : montage van het frame en bevestiging van de melamineplaten

### Ijzerwaren

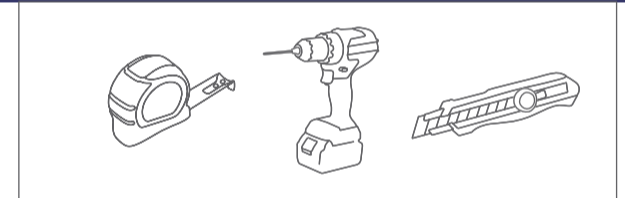
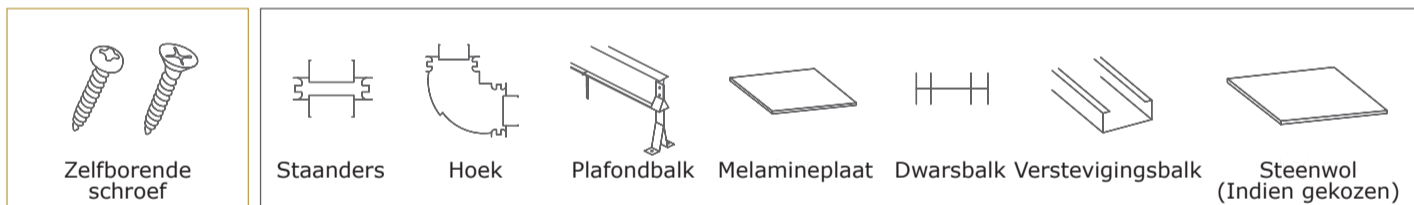

- Schuif de staanders en de hoeken op de hoekijzers
- Plaats de bovenregels en schroef ze vast aan de hoeken
- Verdeel de balken ongeveer op gelijke afstand en schroef ze vast in de bovenregels
- Schroef de U-vormige verstevigingsbalken op de balken en de hoeken
- controleer in deze fase of alles waterpas is
- Schroef de melamineplaten vast
- Plaats de dwarsbalken
- Schroef alle dwarsbalken vast

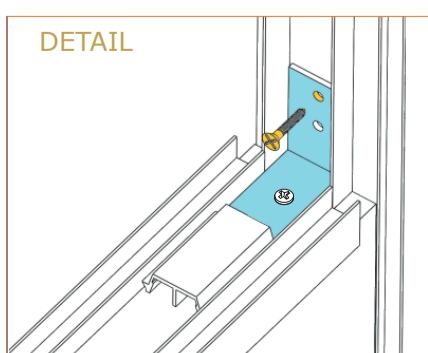
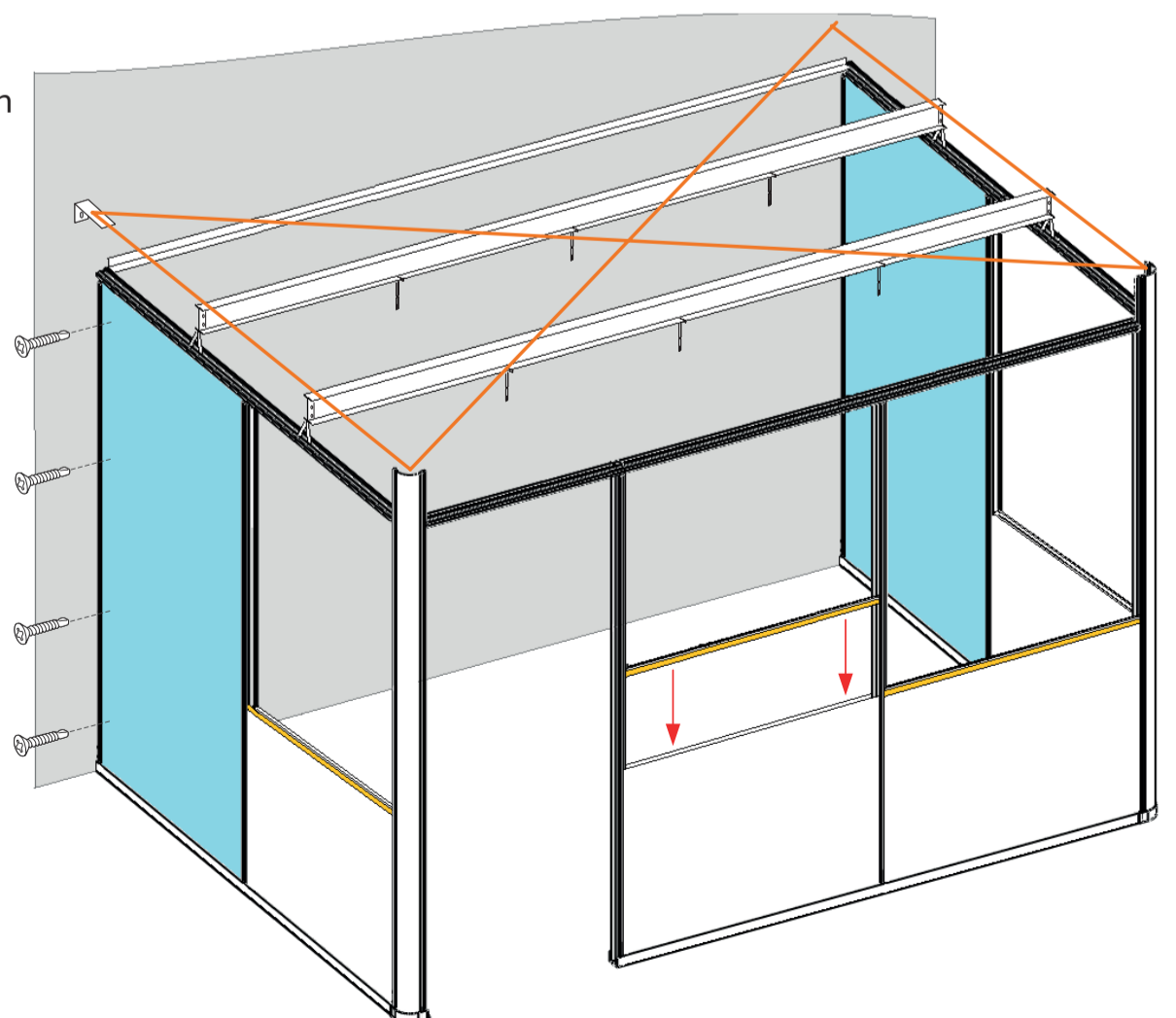

## STAP 3 : Plaatsing van het plafond en de afwerklijst

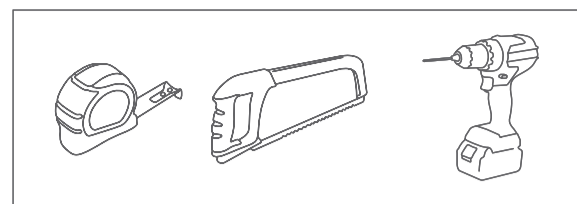

### Ijzerwaren

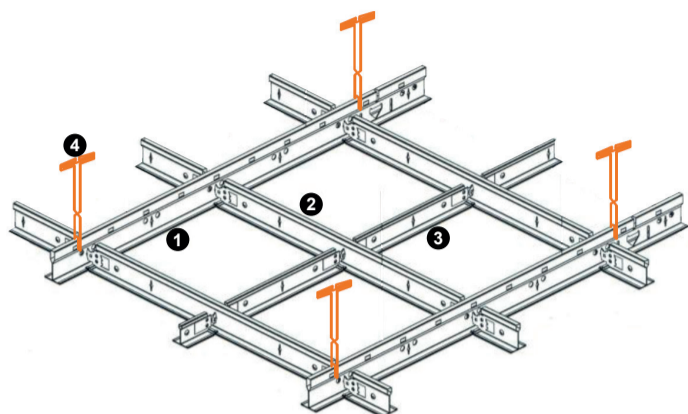
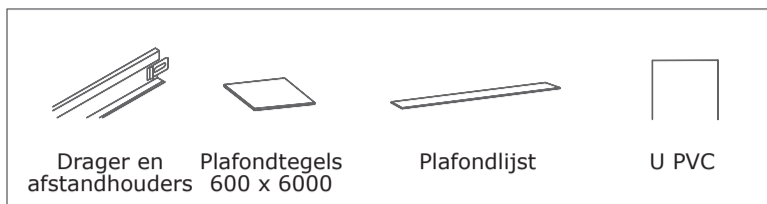

- 1 Drager 3600
- 2 Afstandhouder 1200
- 3 Afstandhouder 600
- 4 Ophangbeugel

Glaswol (indien gekozen)

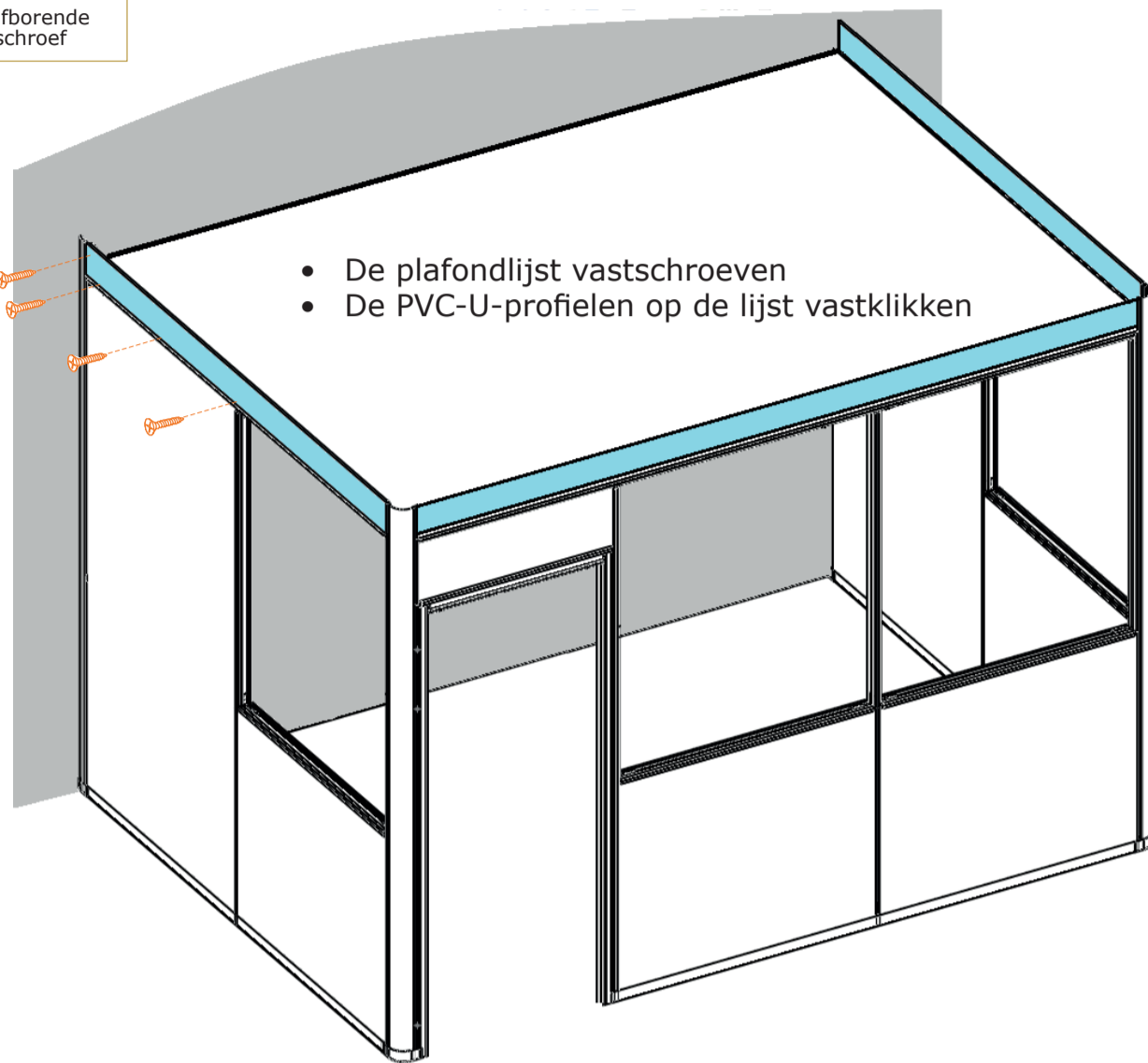
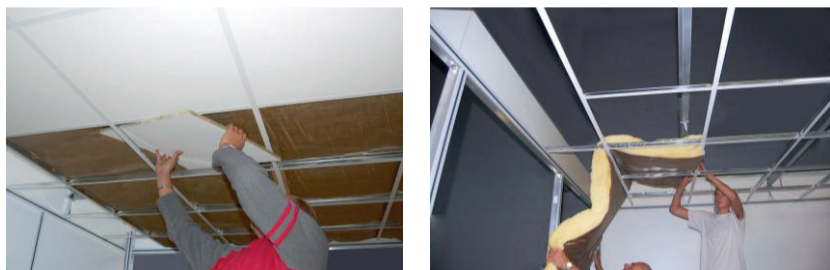

## STAP 4 : Plaatsing van deur, afgeronde hoekafdekking en de omlijsting

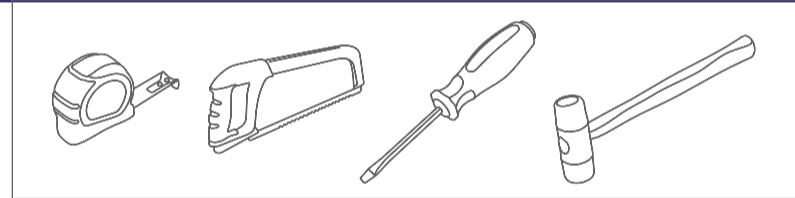

### Ijzerwaren

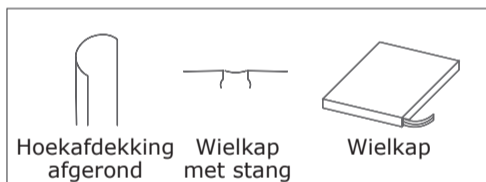

- Plaats de deur, schroef de deurelink en het cilinderslot vast
- Plaats de afgeronde hoekafdekking
- Klik de strips op de stang vast, evenals op de hoek
- Pas de bolvormige strips aan en klik deze vast op de bovenste regel
- Klik de strips vast op de standers

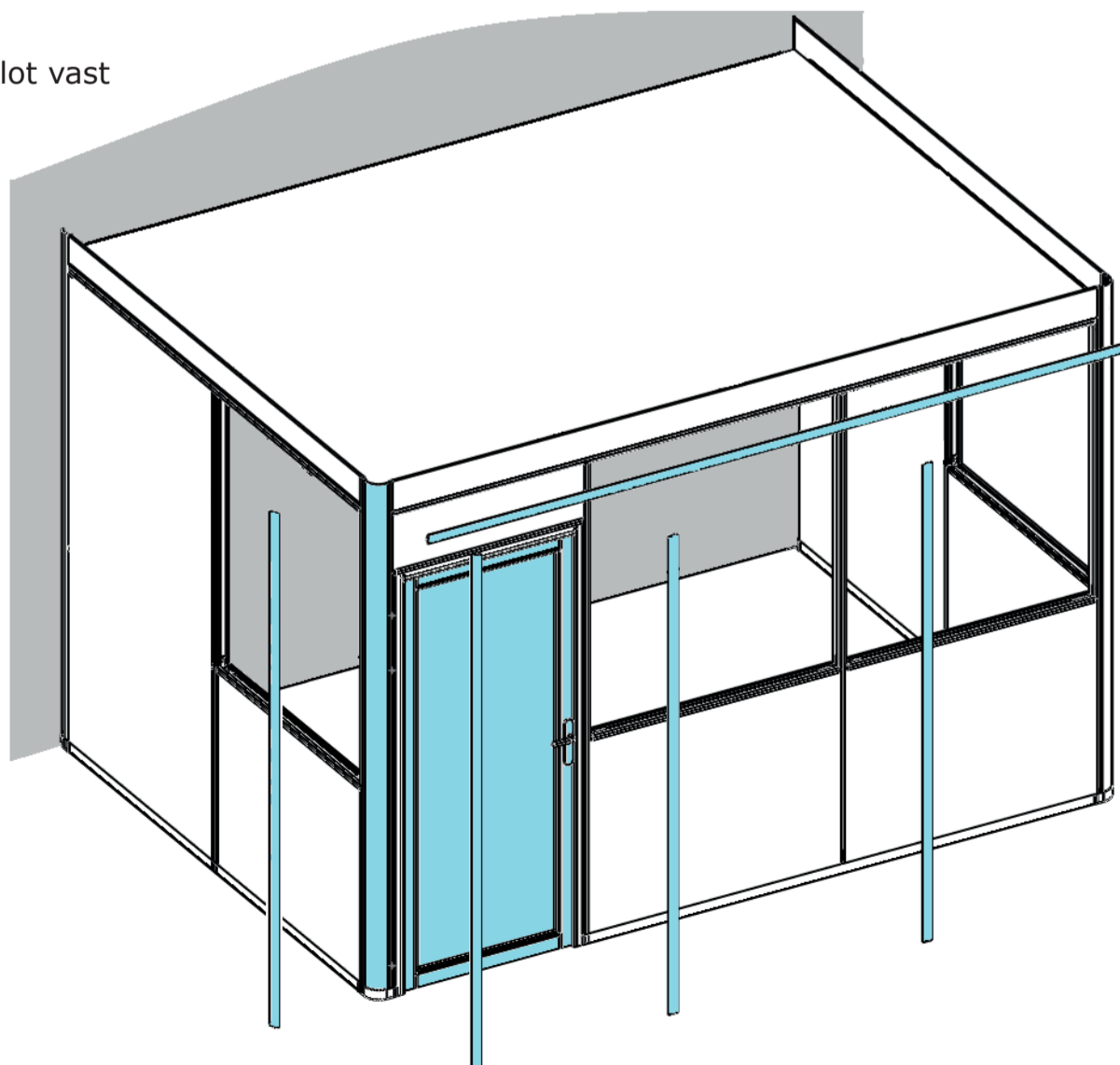

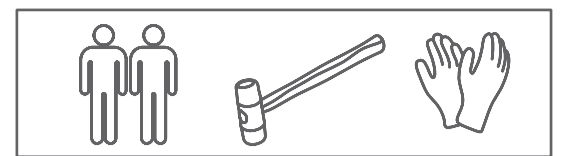

Ijzerwaren

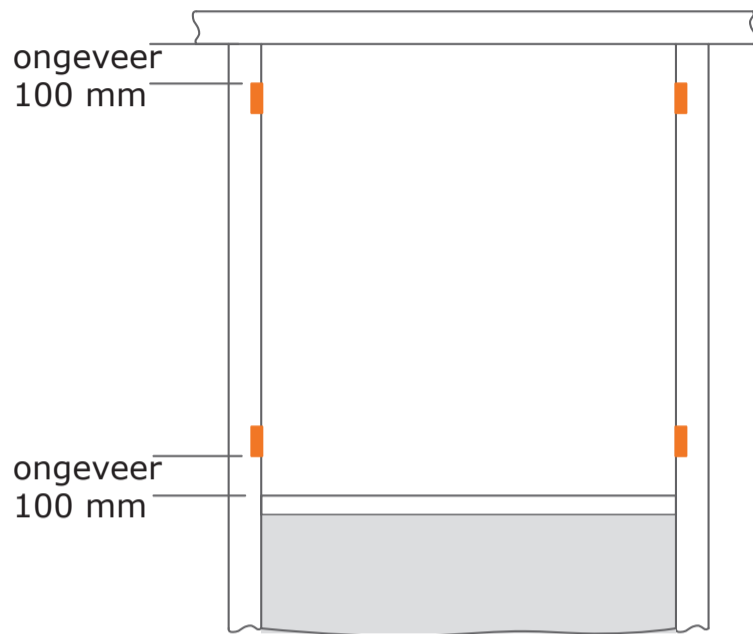
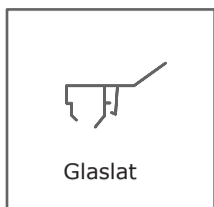

**A)** Bevestig per ruit 4 klemmen in de steunen op ongeveer 100 mm van de boven- en onderkant

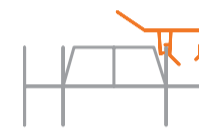
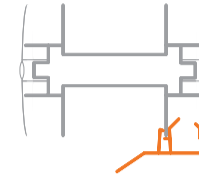

**B)** Bevestig 2 horizontale glaslaten (1 boven, 1 onder) aan één kant.

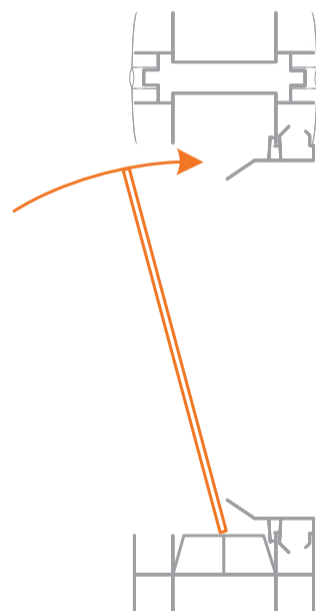

**C)** Plaats het glas, gebruik snijbestendige handschoenen

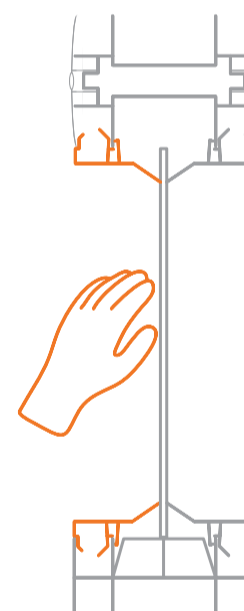

**D)** Het glas op zijn plaats houden  
 • De resterende horizontale glaslaten vastklikken  
 • Tot slot de verticale glaslaten bevestigen

## KANTOORUNIT IN HOEK

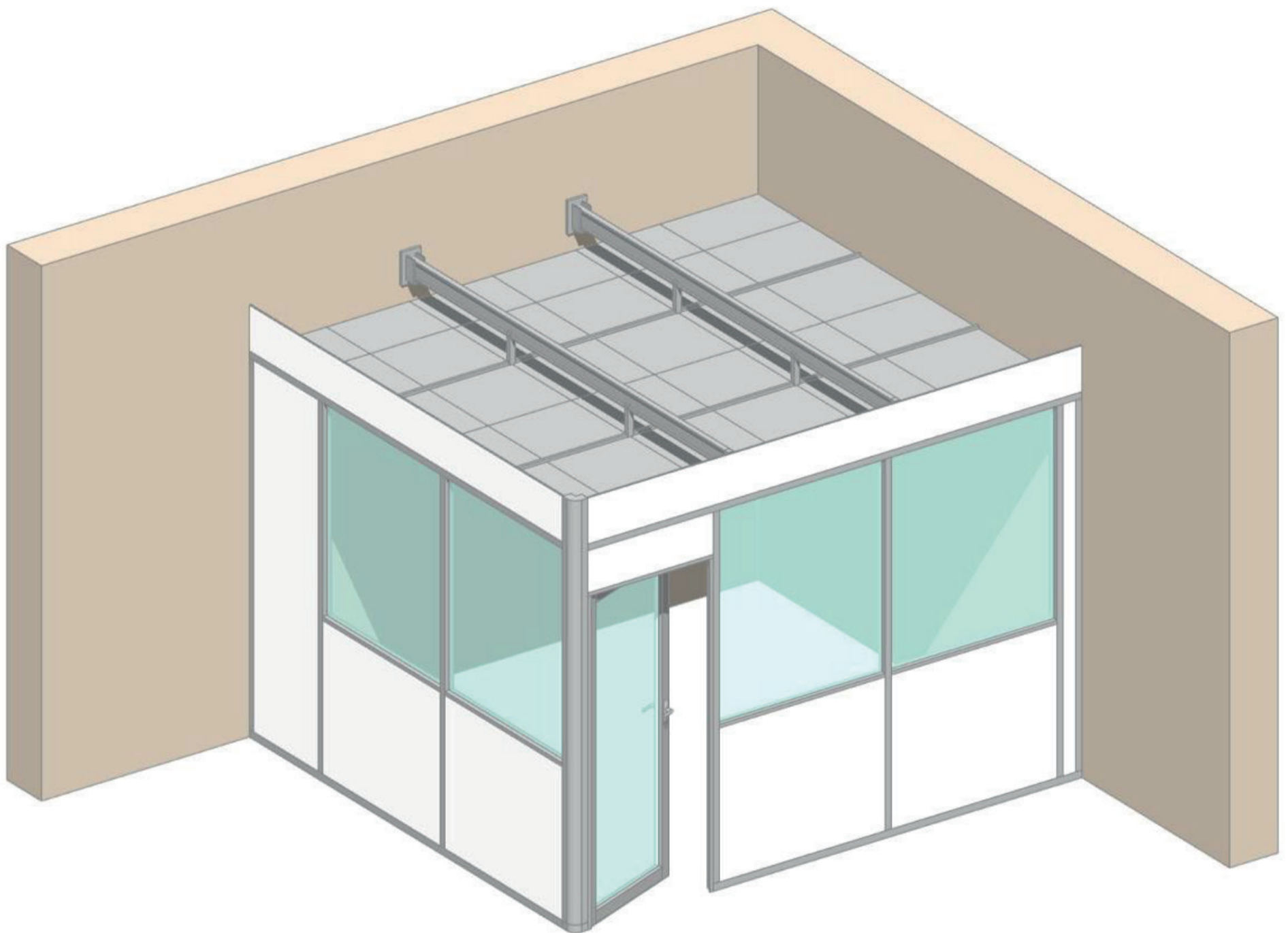

## STAP 1 : plaatsen van de rails en het bevestigen van de beugels

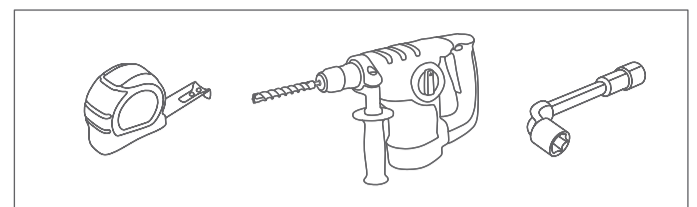

### Ijzerwaren

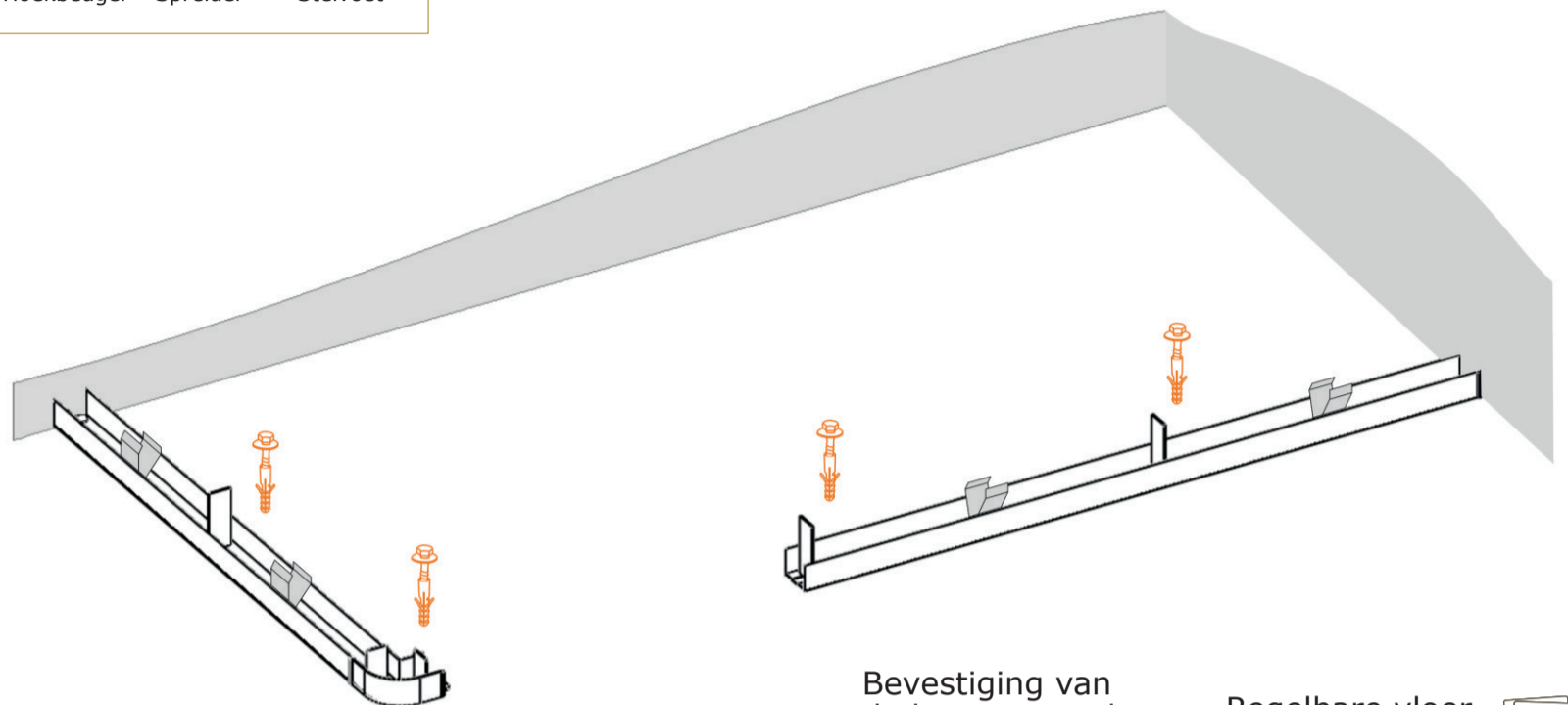
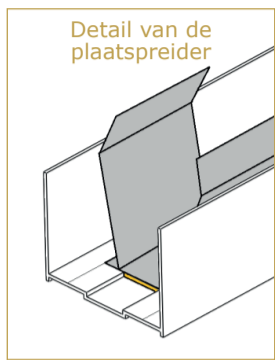
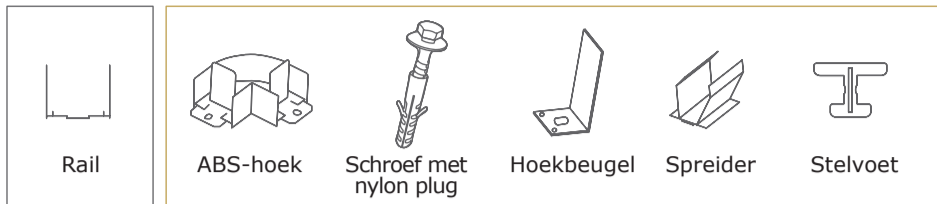

Bevestiging van de kantoorwand op de grond

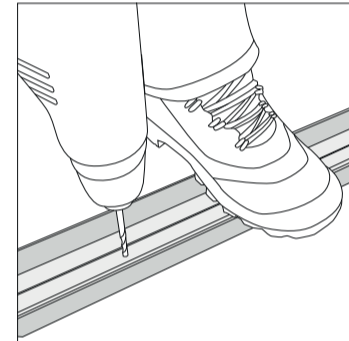

Regelbare vloer tot 40 mm

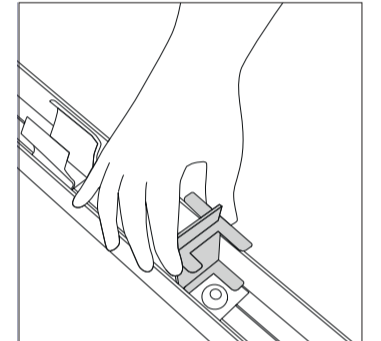

## STAP 2 : montage van het frame en bevestiging van de melamineplaten

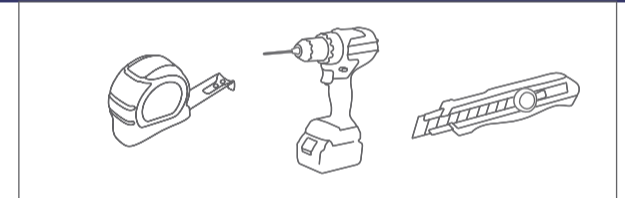

### Ijzerwaren

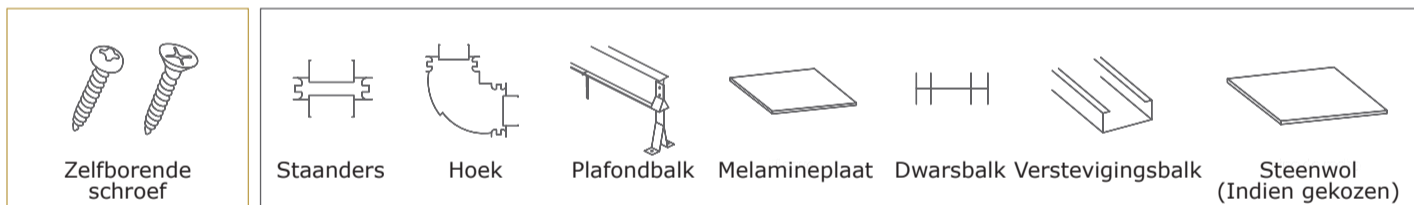

- Schuif de staanders en de hoeken op de hoekijzers
- Plaats de bovenregels en schroef ze vast aan de hoeken
- Verdeel de balken ongeveer op gelijke afstand en schroef ze vast in de bovenregels
- Schroef de U-vormige verstevigingsbalken op de balken en de hoeken
- controleer in deze fase of alles waterpas is
- Schroef de melamineplaten vast
- Plaats de dwarsbalken
- Schroef alle dwarsbalken vast

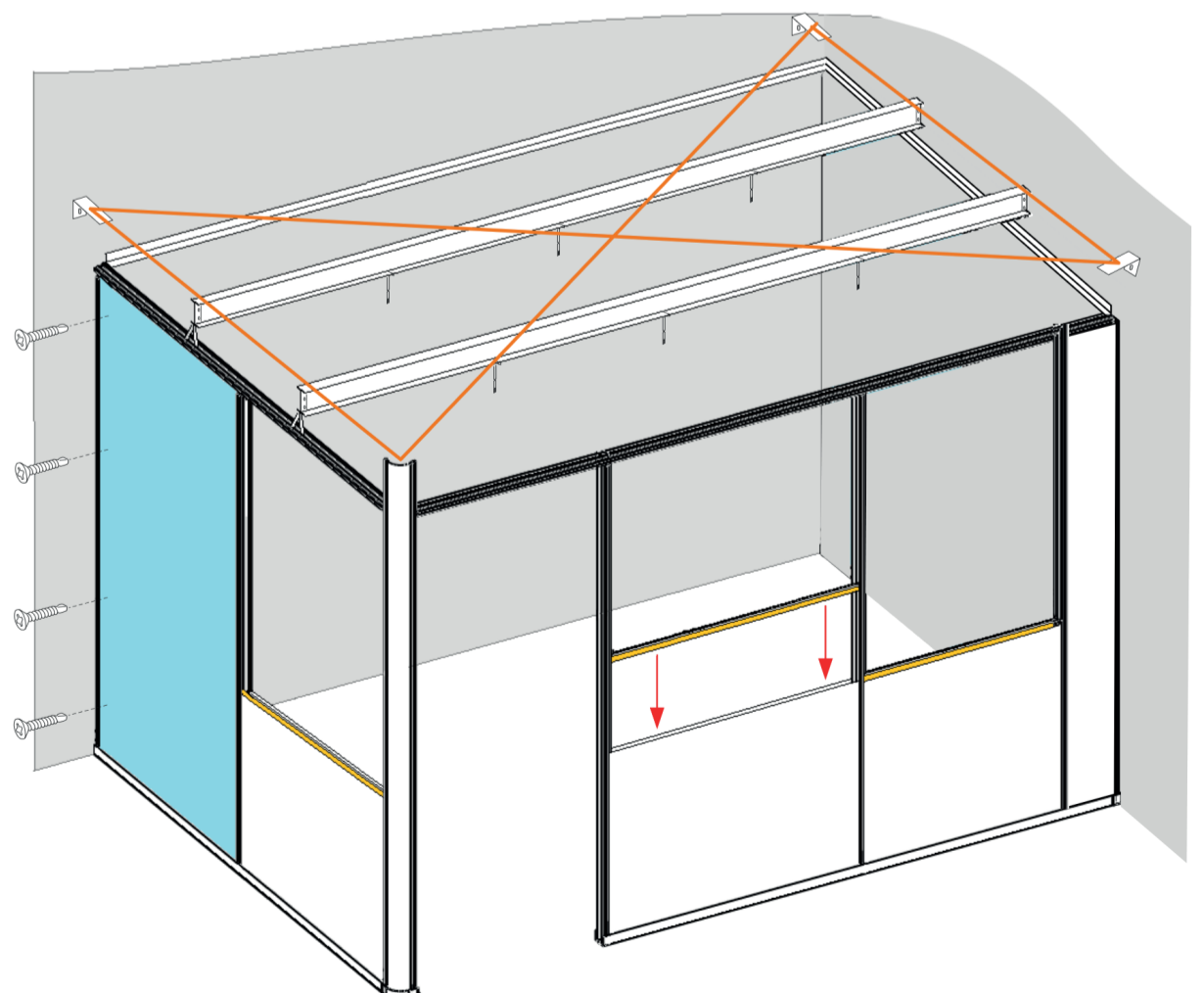
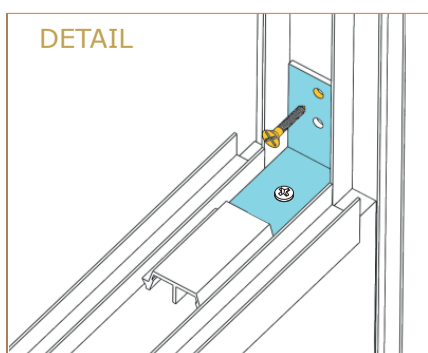

## STAP 3 : Plaatsing van het plafond en de afwerklijst

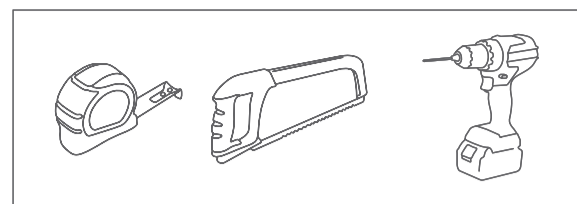

### Ijzerwaren

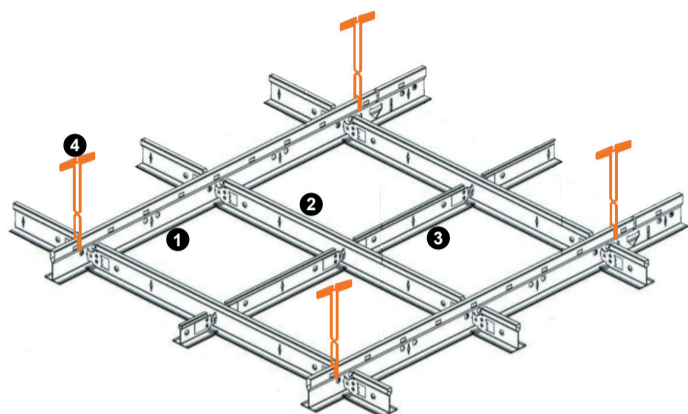
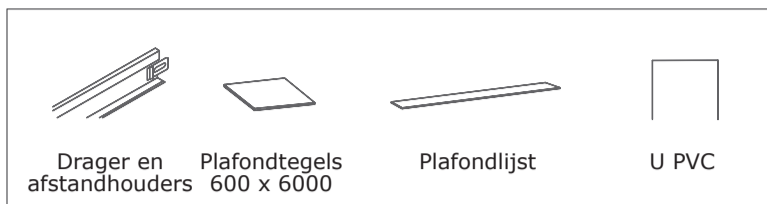

- 1 Drager 3600
- 2 Afstandhouder 1200
- 3 Afstandhouder 600
- 4 Ophangbeugel

Glaswol (indien gekozen)

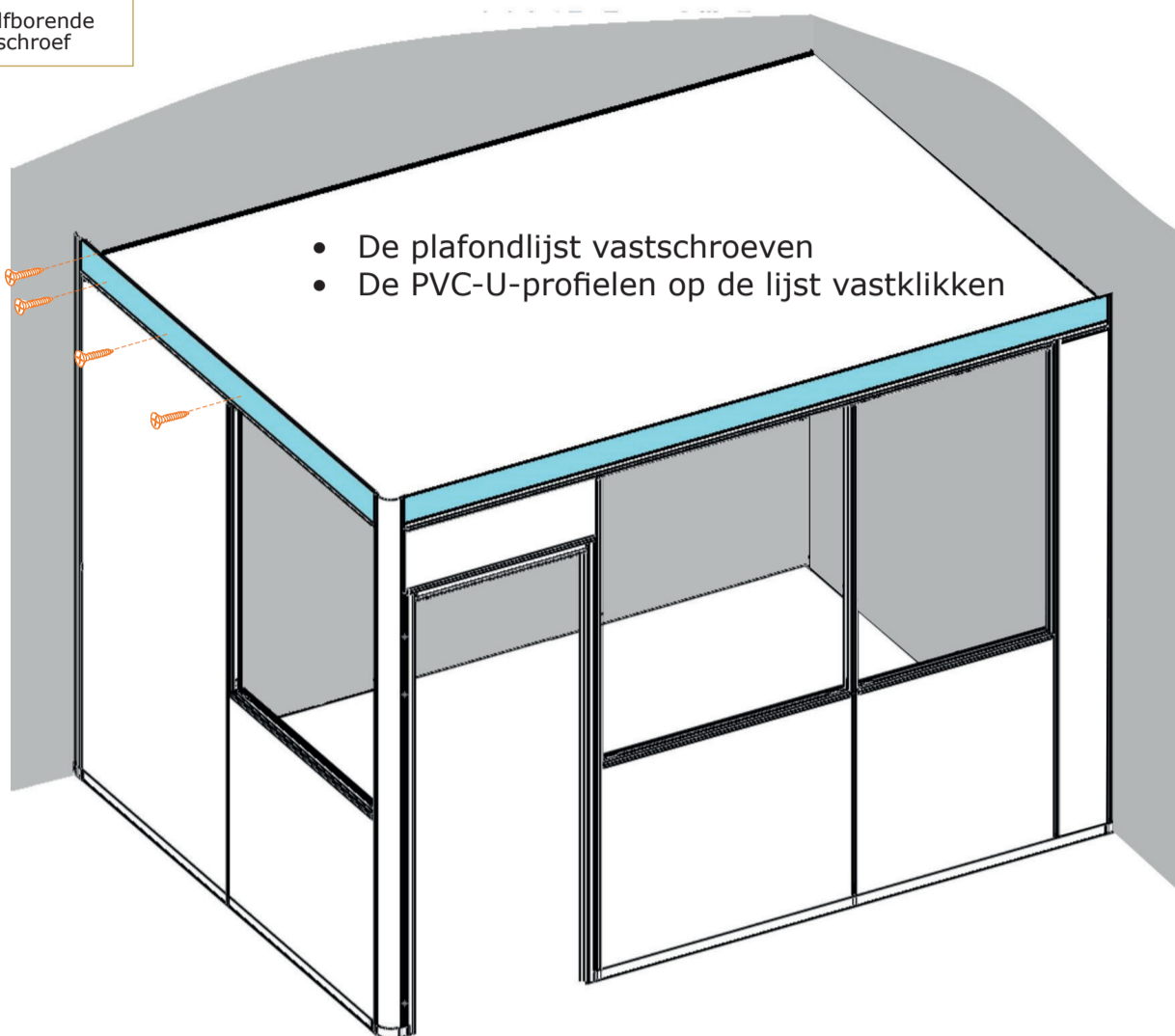
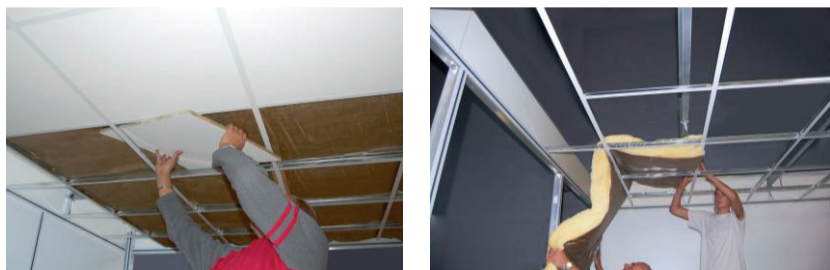

## STAP 4 : Plaatsing van deur, afgeronde hoekafdekking en de omlijsting

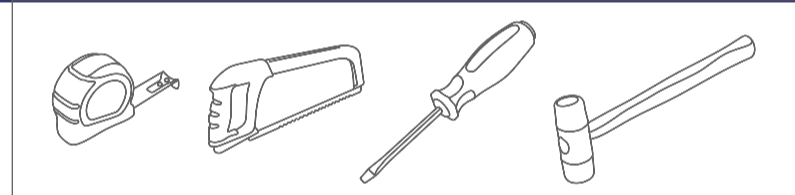

### Ijzerwaren

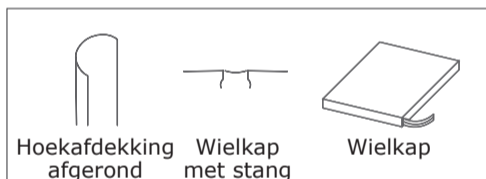

- Plaats de deur, schroef de deurelink en het cilinderslot vast
- Plaats de afgeronde hoekafdekking
- Klik de strips op de stang vast, evenals op de hoek
- Pas de bolvormige strips aan en klik deze vast op de bovenste regel
- Klik de strips vast op de standers

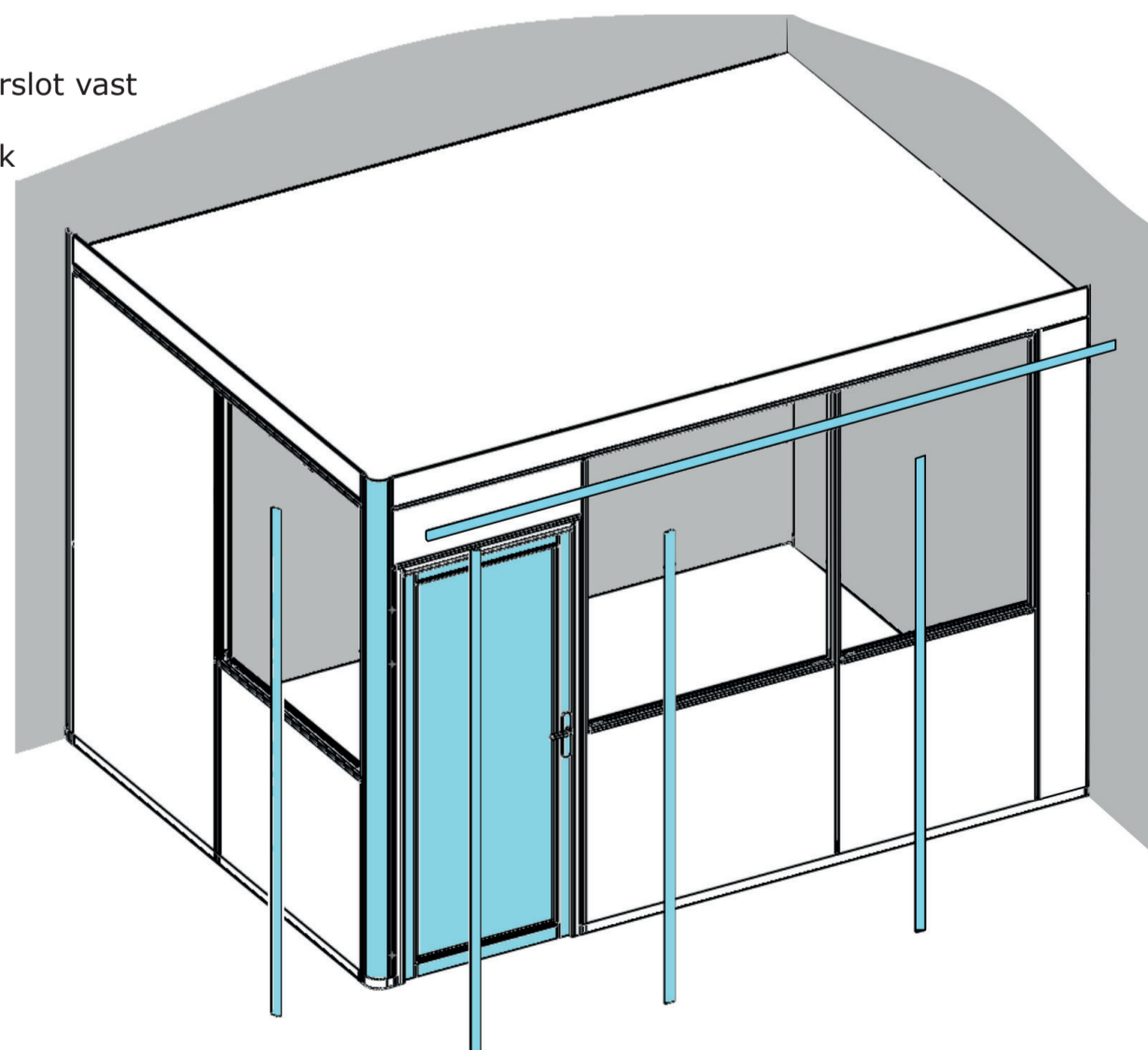

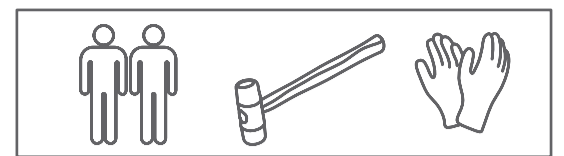

Ijzerwaren

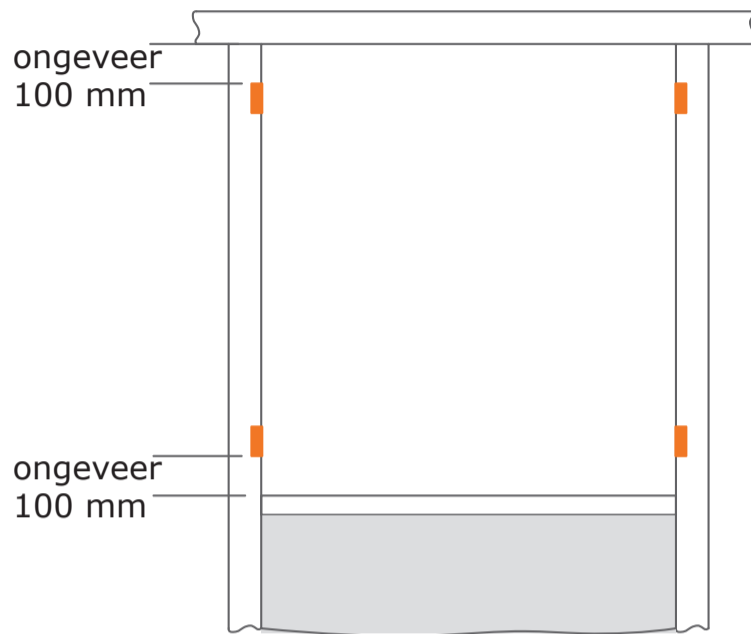
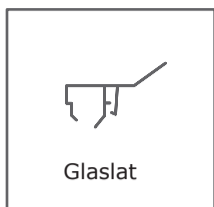

**A)** Bevestig per ruit 4 klemmen in de steunen op ongeveer 100 mm van de boven- en onderkant

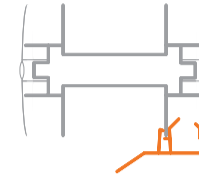

**B)** Bevestig 2 horizontale glaslaten (1 boven, 1 onder) aan één kant.

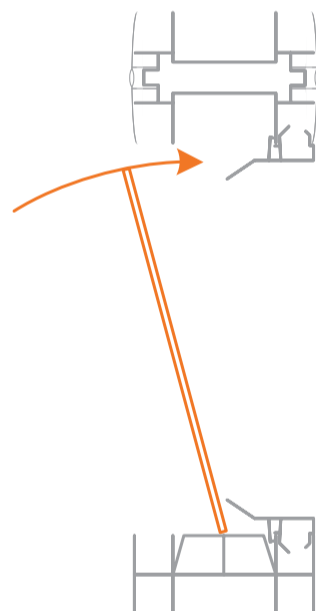

**C)** Plaats het glas, gebruik snijbestendige handschoenen

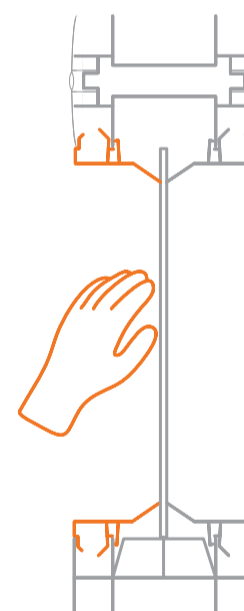

**D)** Het glas op zijn plaats houden

- De resterende horizontale glaslaten vastklikken
- Tot slot de verticale glaslaten bevestigen